

HCDC®

CZH-LABS.com

**8 Output DC Power Distribution Block Module
for 15/30/45A Powerpole Connectors**

Model: HD062



Features:

- HCDC HD062 8 output ports DC power distribution block module for 15/30/45A anderson powerpole connectors.
- Maximum voltage: 60V. Maximum current (input or total output): 45 Amp.
- Enclosure: High quality aluminum enclosure, thickness 1.5mm / 0.06". Support screw mount, wall mount, of course can also be placed on the desktop. Detachable screw mount brackets, supports top or right angle mount.
- Packing list: 1x HD062 distribution module, 9 black powerpole housings, 9 red powerpole housings, 9 PVC cover flame retardant sleeve, 16 silver plated copper 30A 14-12AWG powerpole contacts, 2x tinned copper 45A 12-10AWG powerpole contacts.
- Overall Dimensions(not include external plugs): L 140mm x W 39.2mm x H 33mm / 5.51" x 1.54" x 1.30". Net weight(not include external plugs): 126g.



XikenTech HD062 Schematic

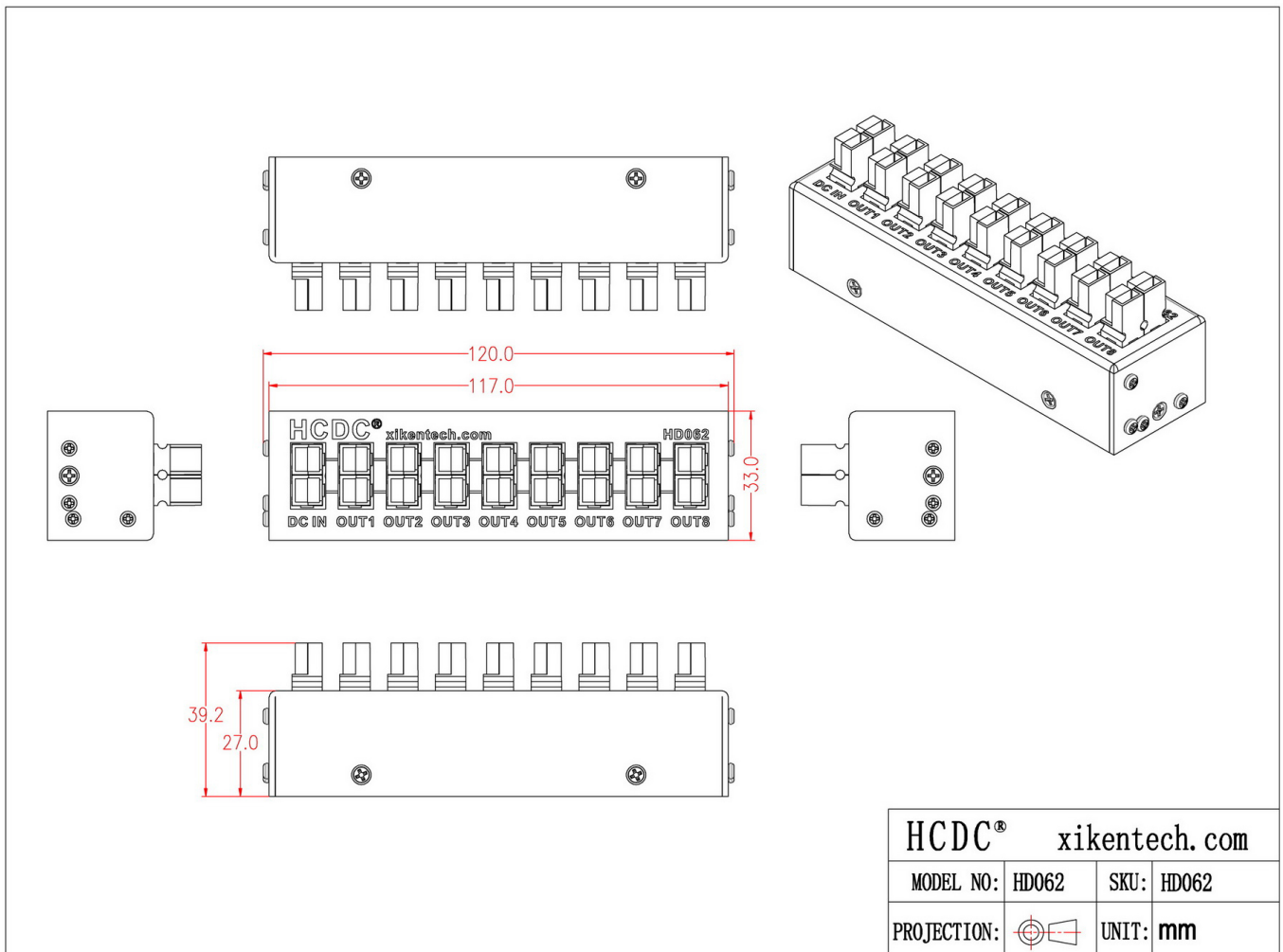
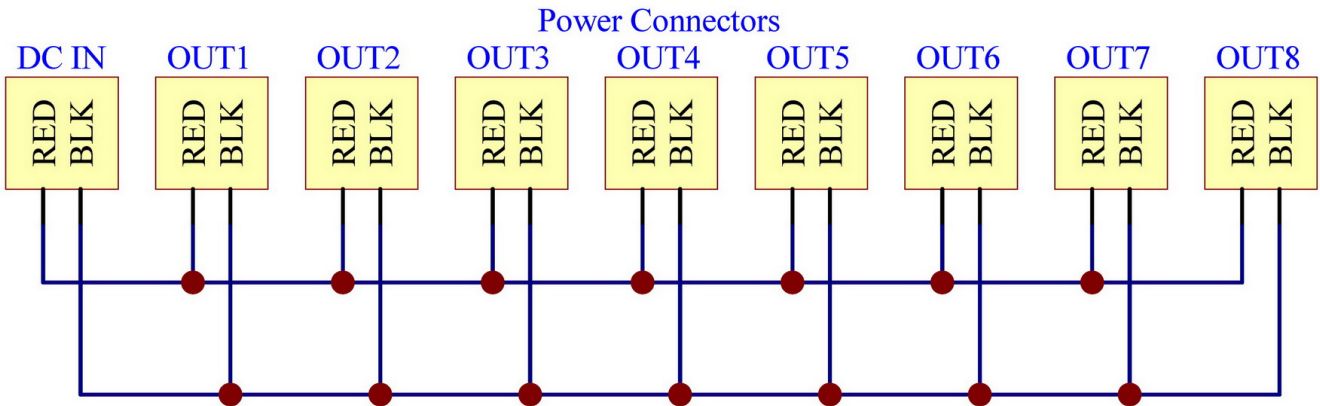

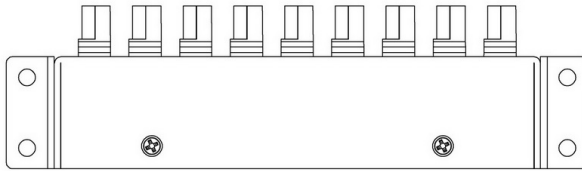
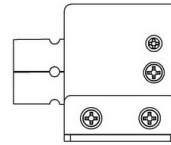
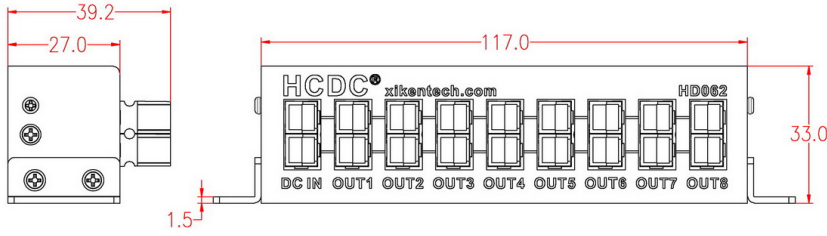
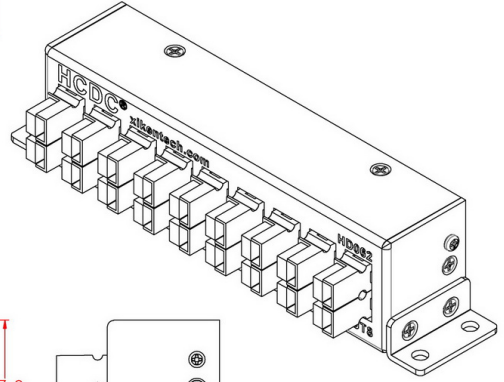

HCDC®		xikentech.com	
MODEL NO:	HD062	SKU:	HD062
PROJECTION:		UNIT:	mm

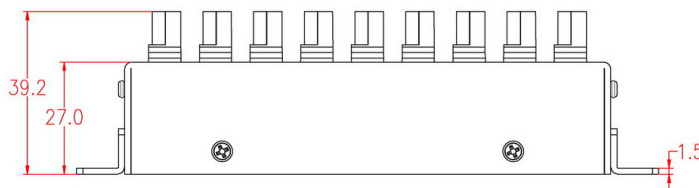
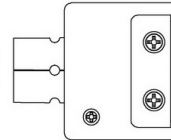
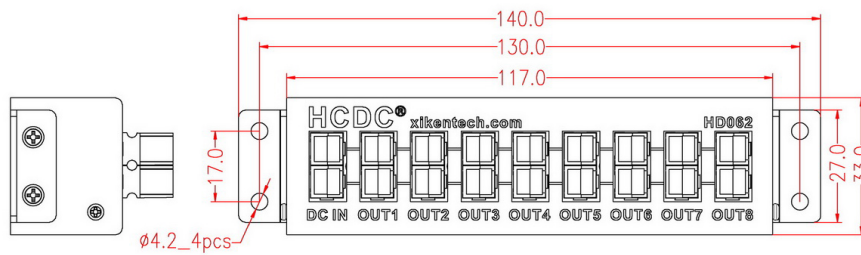
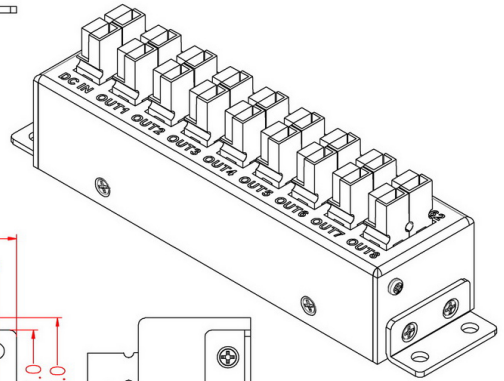
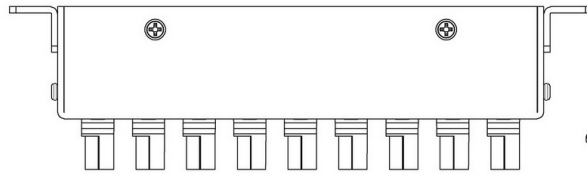

HCDC®		xikentech.com	
MODEL NO:	HD062	SKU:	HD062
PROJECTION:		UNIT:	mm