

# OONO<sup>®</sup>

## CZH-LABS.com

**AC or DC Power Distribution Module**  
**with Switch and Fuse, DIN rail or Screw Mounting**  
**Model: D-1620 to D-1627 series**

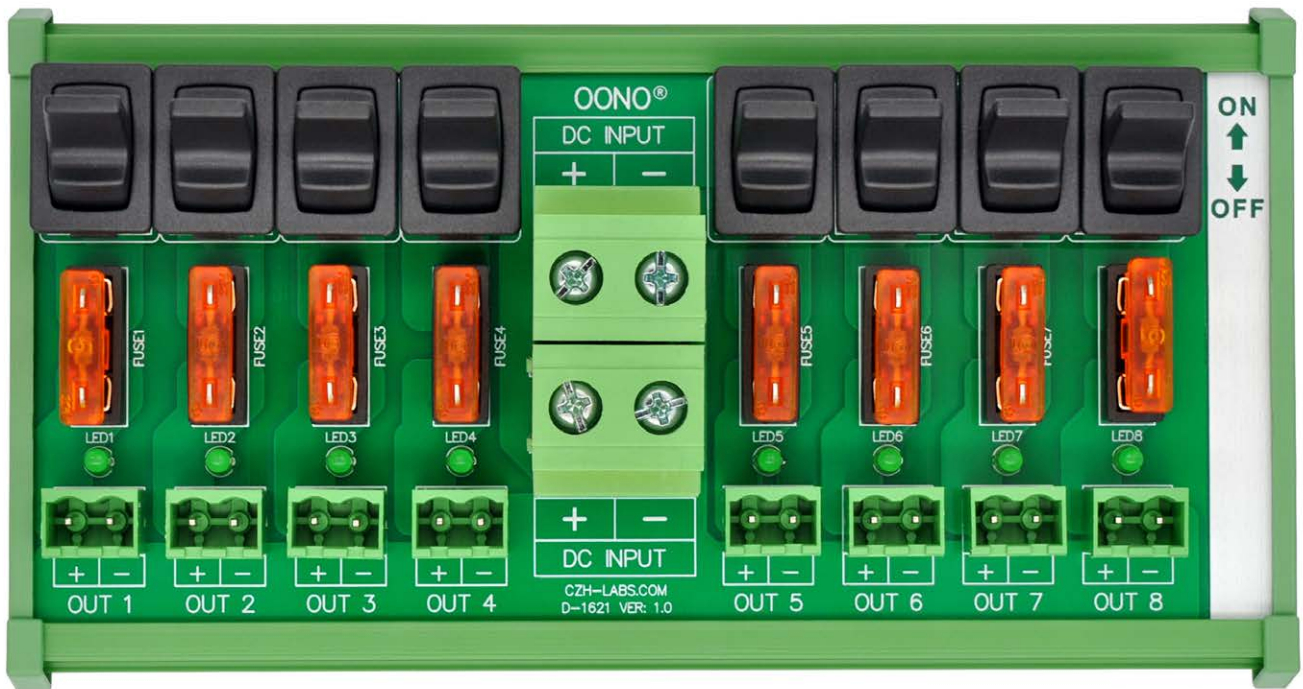

## FEATURES:

- Dual input screw terminal block, the direction of the input terminal wiring can be flexibly selected, and it can also be extended to other modules as its input source. Rated current 52 Amp. Pitch 10.16mm/0.4", wire range 20 - 6AWG / 10mm square, strip length 10mm, screw - metric M4.
- Each output terminal is equipped with an independent switch, which can flexibly control the power supply of each load device. Paddle and Rocker switch style available.
- Each output terminal is equipped with an independent fuse, which can protect the power supply of each load device and are not affected by each other. The fuse holder supports fuse replacement, making fuse replacement easy. The AC series uses a 5x20mm glass tube fuse, and the DC series uses a medium blade ATO fuse.
- Each output terminal is equipped with a green LED power indicator. The indicator light comes on when power is on and goes off when the switch is off or the fuse fails.
- Each output terminal is equipped with a pluggable terminal block. Top and Side wiring style available. Pitch 5.08mm/0.2", wire range 28 - 12AWG / 2.5mm square, stripping length 7mm, screw - metric M2.5 slotted.
- High quality fireproof nylon material DIN rail mount carrier, can support width 35mm, 32mm or 15mm rail. A pair of DIN rail to Wall mounting adapter brackets are also included, which will support wall or wood panel mounting.
- UL CE CQC certified terminal blocks. UL 94-V0 certified PCB, and UL CE certified DIN rail mount carrier. UL certified fuse holder and fuse. UL CE certified switch.

## Version List:

SKU	Voltage	Output Channel	Switch Style	Terminal Block Style
D-1620TVL	DC 5 - 32V	4	Rocker Switch	Top Wiring
D-1620TKRL	DC 5 - 32V	4	Paddle Switch	Side Wiring
D-1621TVL	DC 5 - 32V	8	Rocker Switch	Top Wiring
D-1621TKRL	DC 5 - 32V	8	Paddle Switch	Side Wiring
D-1622TVL	DC 5 - 32V	12	Rocker Switch	Top Wiring
D-1622TKRL	DC 5 - 32V	12	Paddle Switch	Side Wiring
D-1623TVL	DC 5 - 32V	16	Rocker Switch	Top Wiring
D-1623TKRL	DC 5 - 32V	16	Paddle Switch	Side Wiring
D-1624TVL	AC 24 - 250V	4	Rocker Switch	Top Wiring
D-1624TKRL	AC 24 - 250V	4	Paddle Switch	Side Wiring
D-1625TVL	AC 24 - 250V	8	Rocker Switch	Top Wiring
D-1625TKRL	AC 24 - 250V	8	Paddle Switch	Side Wiring
D-1626TVL	AC 24 - 250V	12	Rocker Switch	Top Wiring
D-1626TKRL	AC 24 - 250V	12	Paddle Switch	Side Wiring
D-1627TVL	AC 24 - 250V	16	Rocker Switch	Top Wiring
D-1627TKRL	AC 24 - 250V	16	Paddle Switch	Side Wiring

## Schematic:

### Example D-1621 (DC 8 Channel)

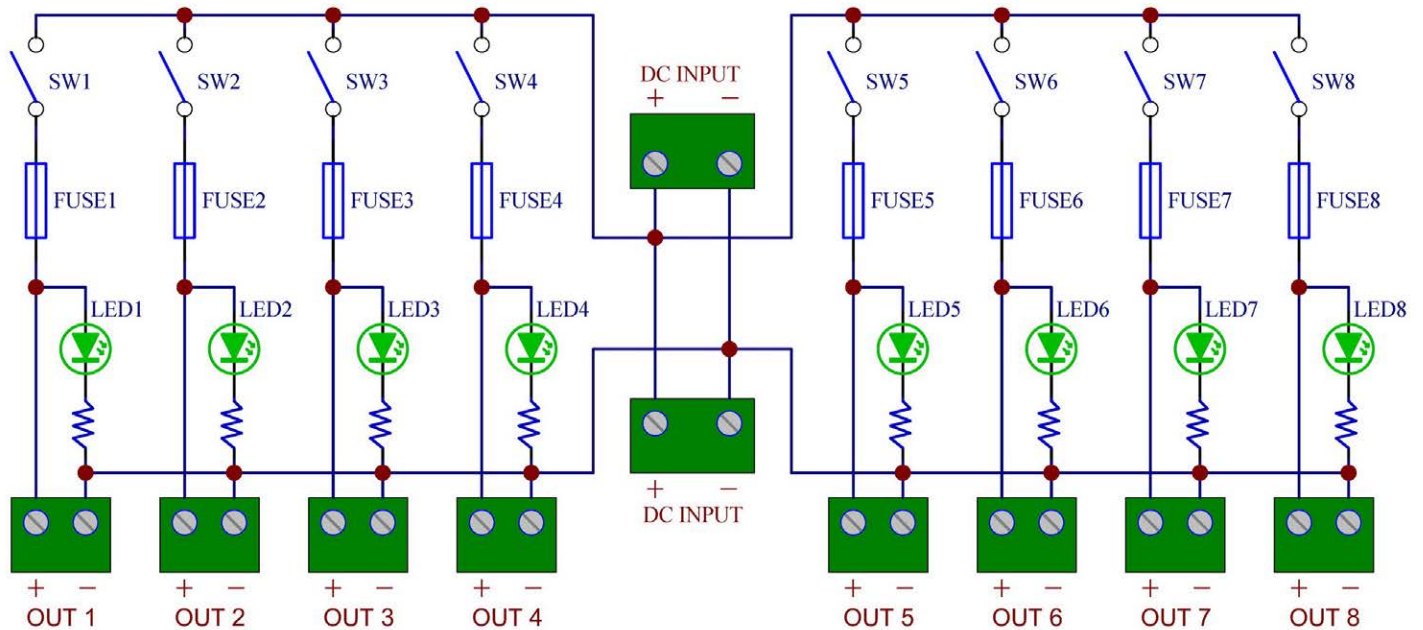

DC series, factory pre-installed fuse value is 5 Amp. you can also replace the fuse, each output port maximum current 10 Amp.

### Example D-1625 (AC 8 Channel)

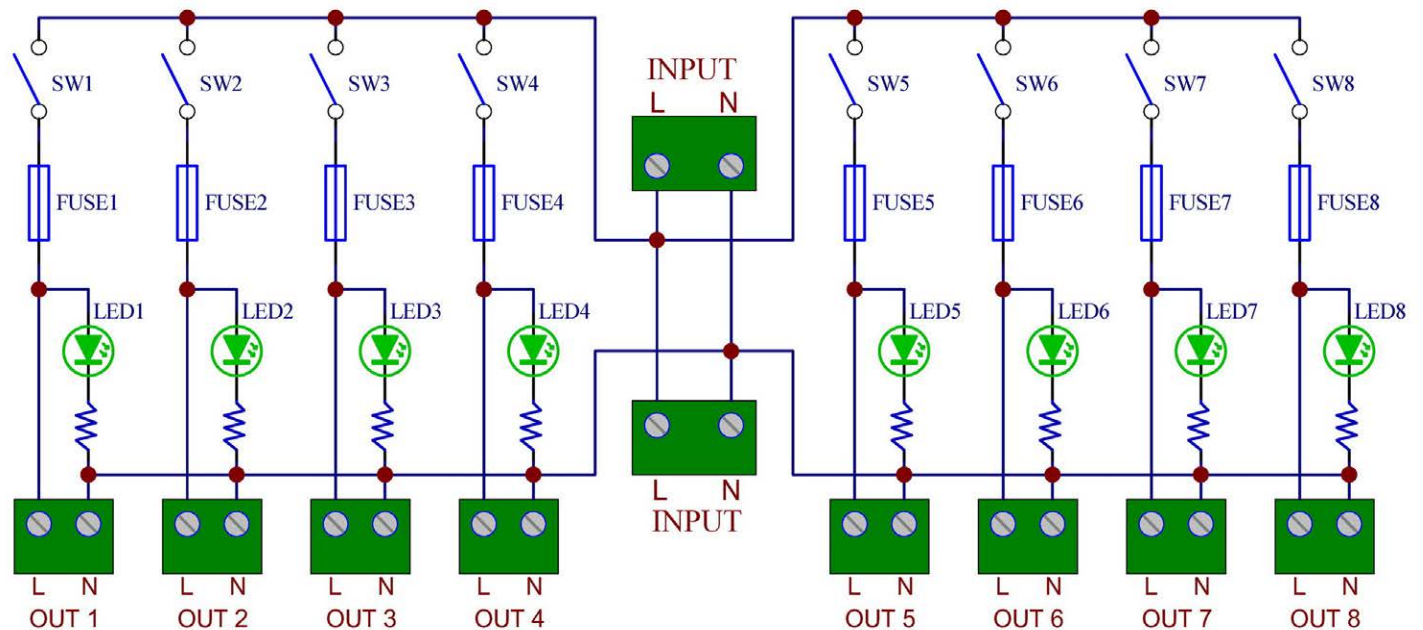

AC series, factory pre-installed fuse value is 4 Amp. you can also replace the fuse, each output port maximum current 6.3 Amp.

## Dimensional Drawings:

We can also provide 3D STP documentation, please contact us if you need it.

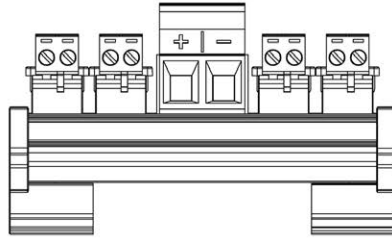
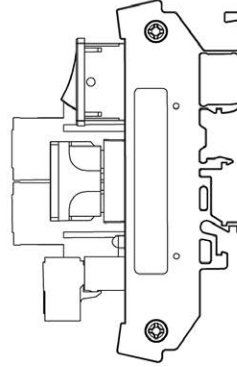
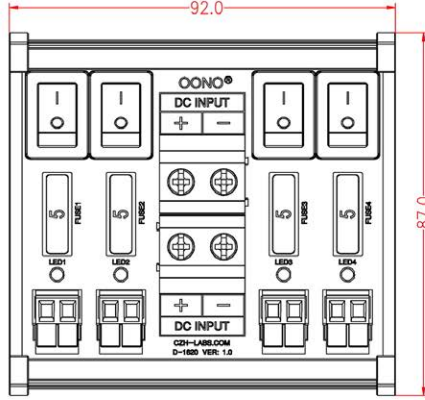
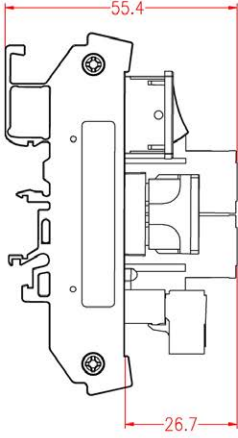
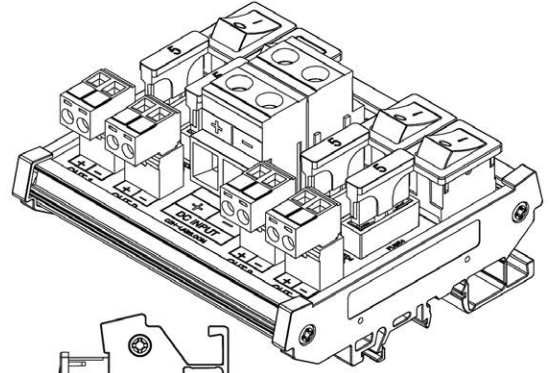
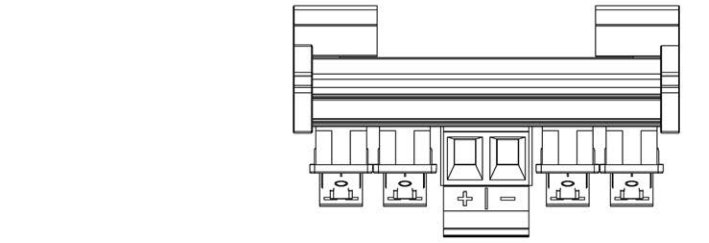

OONO®		czh-labs.com	
MODEL NO:	D-1620TV	SKU:	MD-D1620TV-1
PROJECTION:		UNIT:	mm

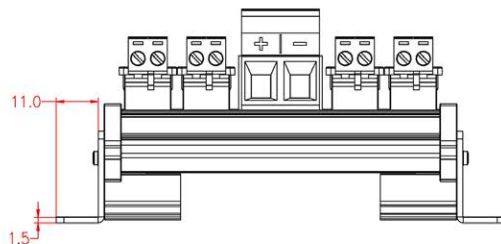
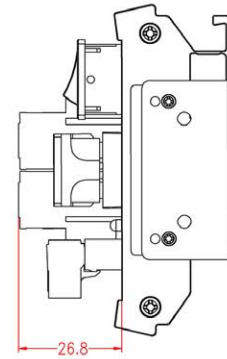
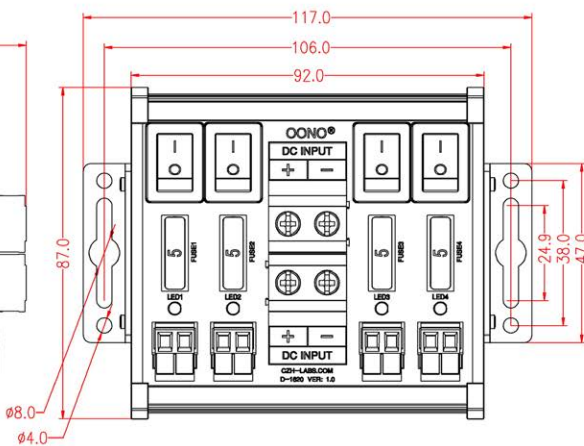
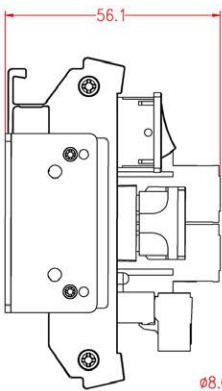
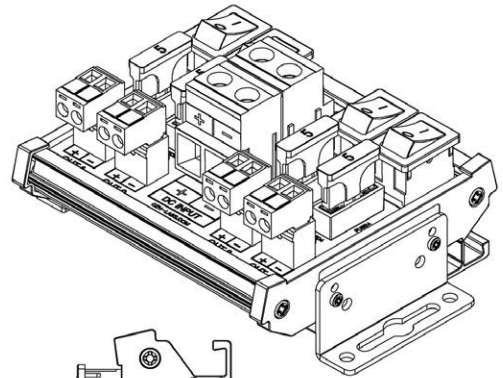
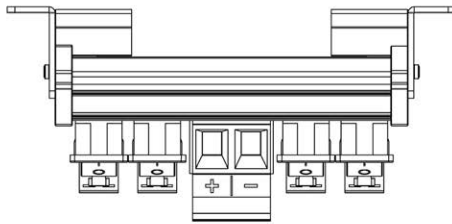

OONO®		czh-labs.com	
MODEL NO:	D-1620TVL	SKU:	MD-D1620TVL-1
PROJECTION:		UNIT:	mm

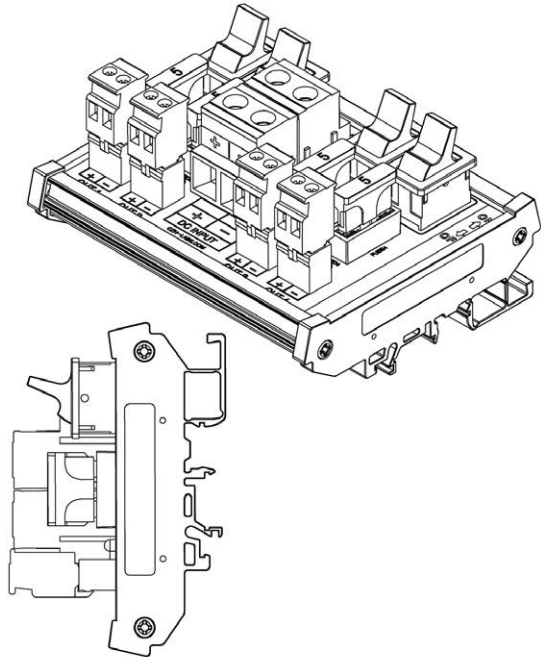
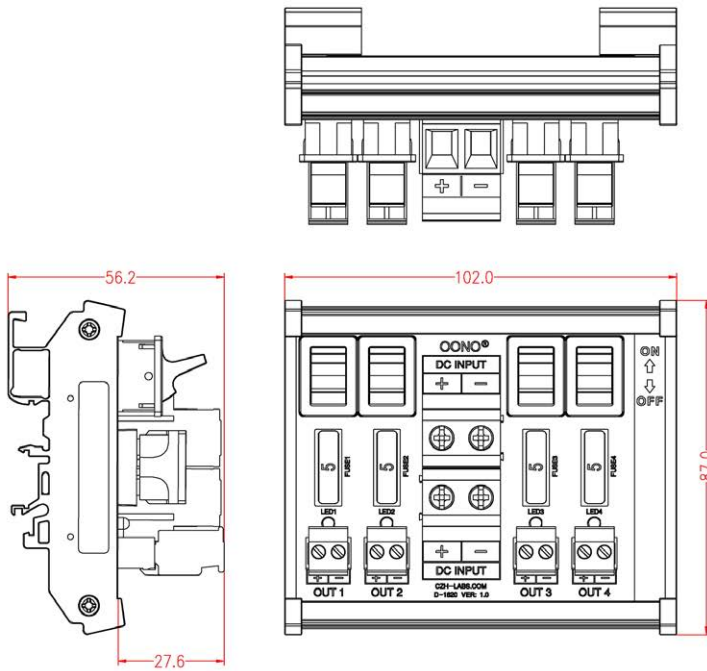

OONO®		czh-labs.com	
MODEL NO:	D-1620TKR	SKU:	MD-D1620TKR-1
PROJECTION:		UNIT:	mm

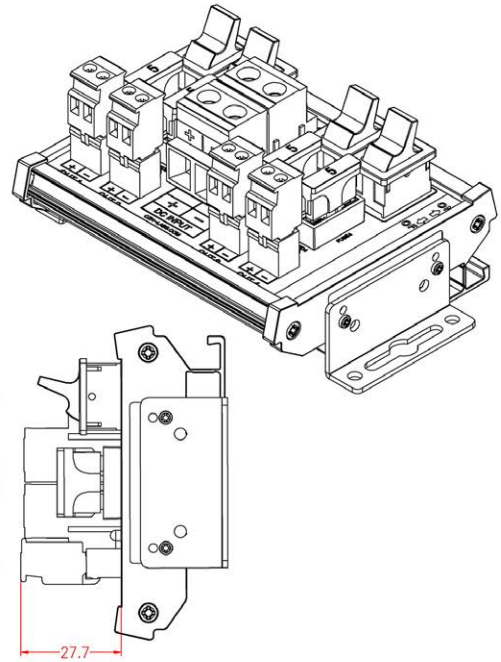
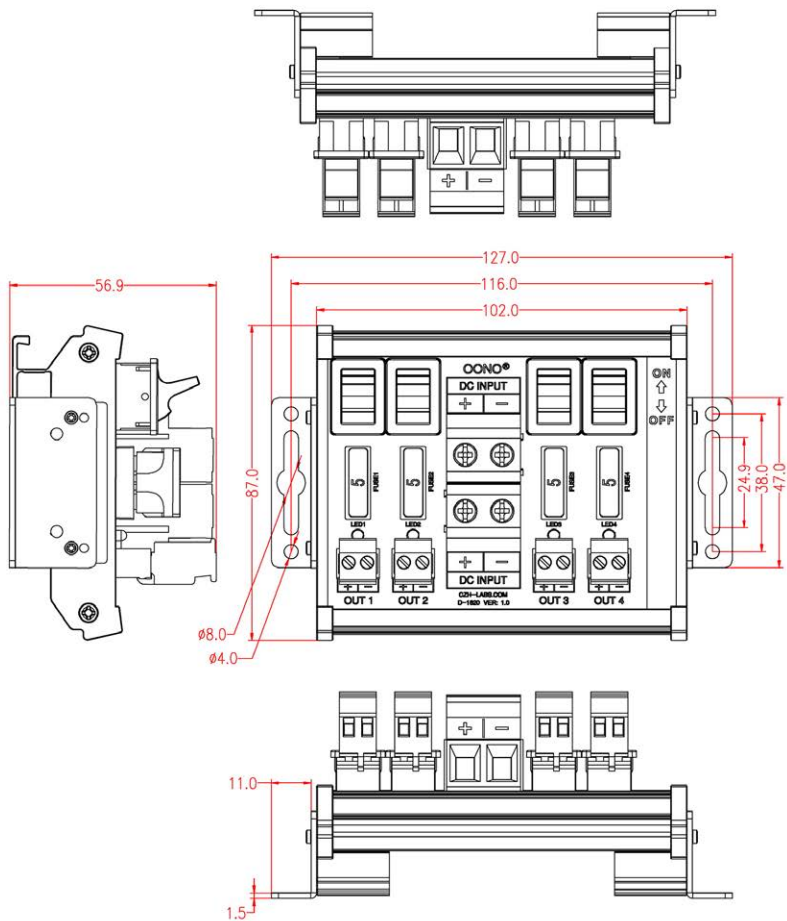

OONO®		czh-labs.com	
MODEL NO:	D-1620TKRL	SKU:	MD-D1620TKRL-1
PROJECTION:		UNIT:	mm

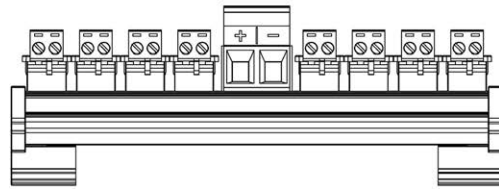
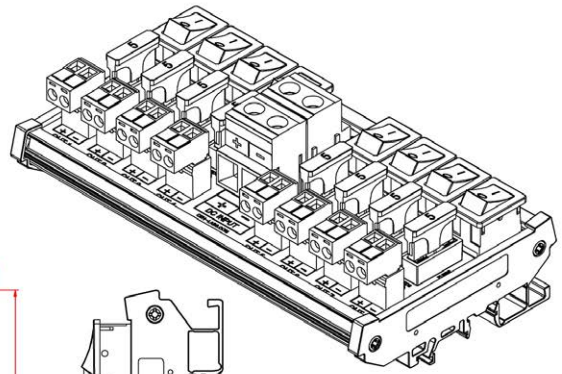
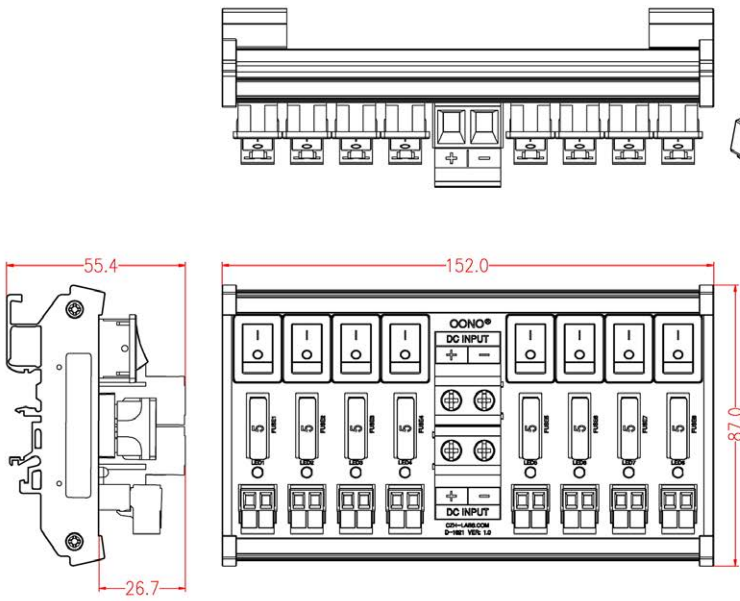

OONO® czh-labs.com

MODEL NO: D-1621TV SKU: MD-D1621TV-1

PROJECTION:  UNIT: mm

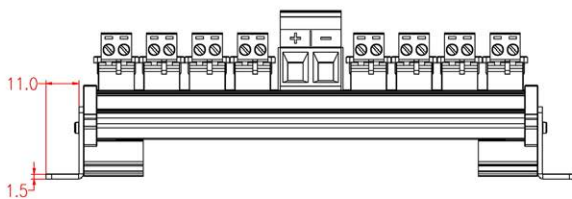
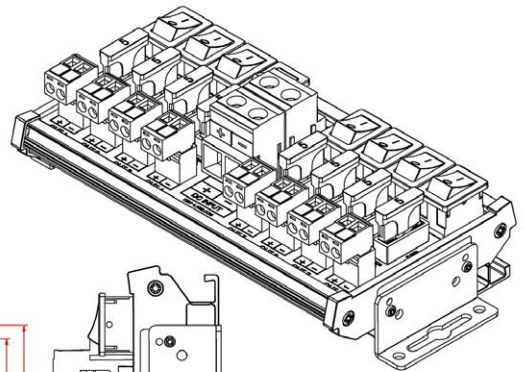
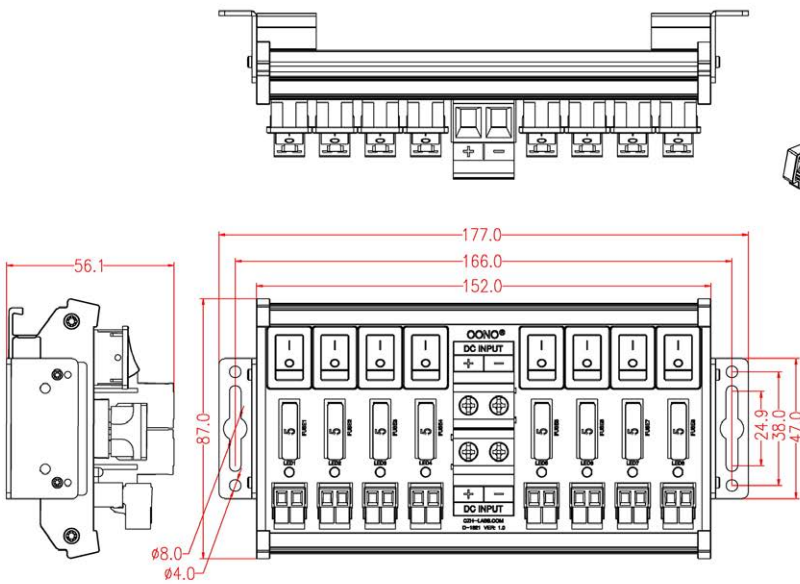

OONO® czh-labs.com

MODEL NO: D-1621TVL SKU: MD-D1621TVL-1

PROJECTION:  UNIT: mm

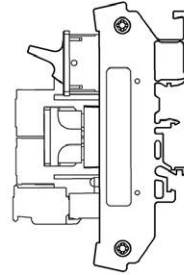
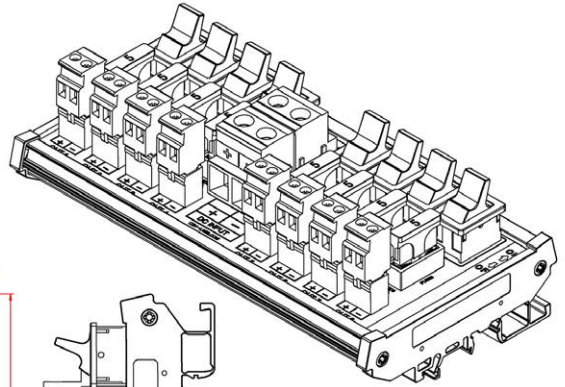
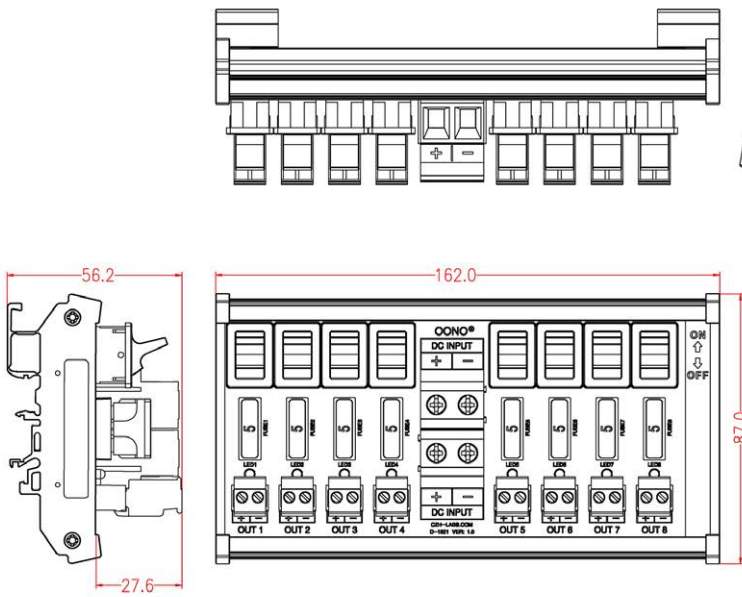

OONO® [czh-labs.com](http://czh-labs.com)

MODEL NO: D-1621TKR SKU: MD-D1621TKR-1

PROJECTION:  UNIT: mm

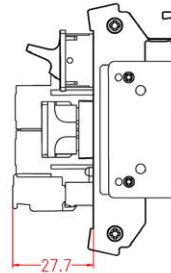
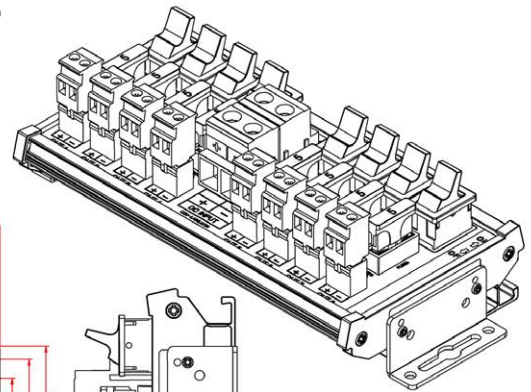
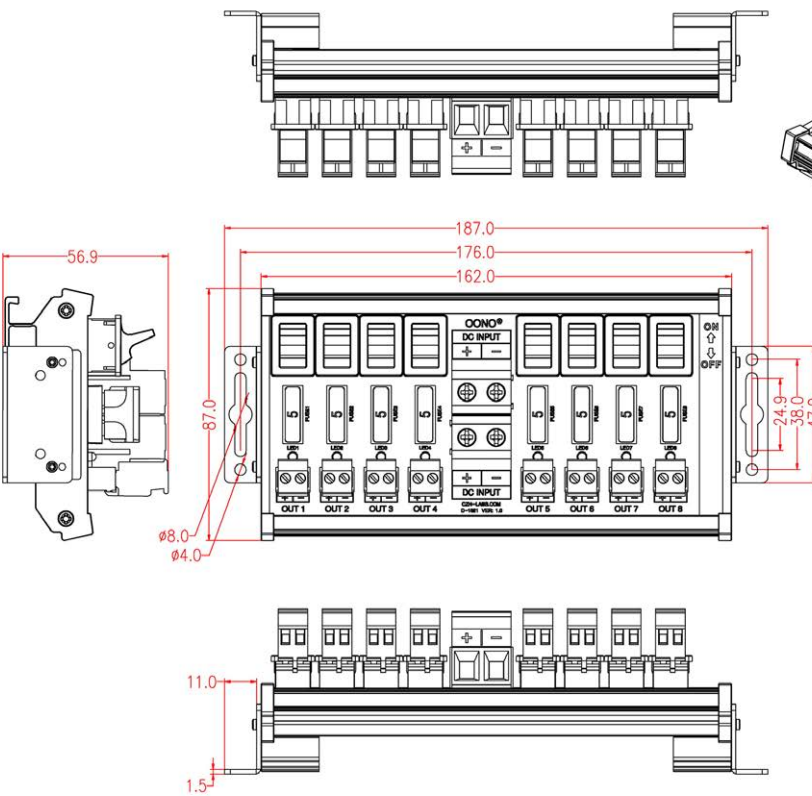

OONO® [czh-labs.com](http://czh-labs.com)

MODEL NO: D-1621TKRL SKU: MD-D1621TKRL-1

PROJECTION:  UNIT: mm

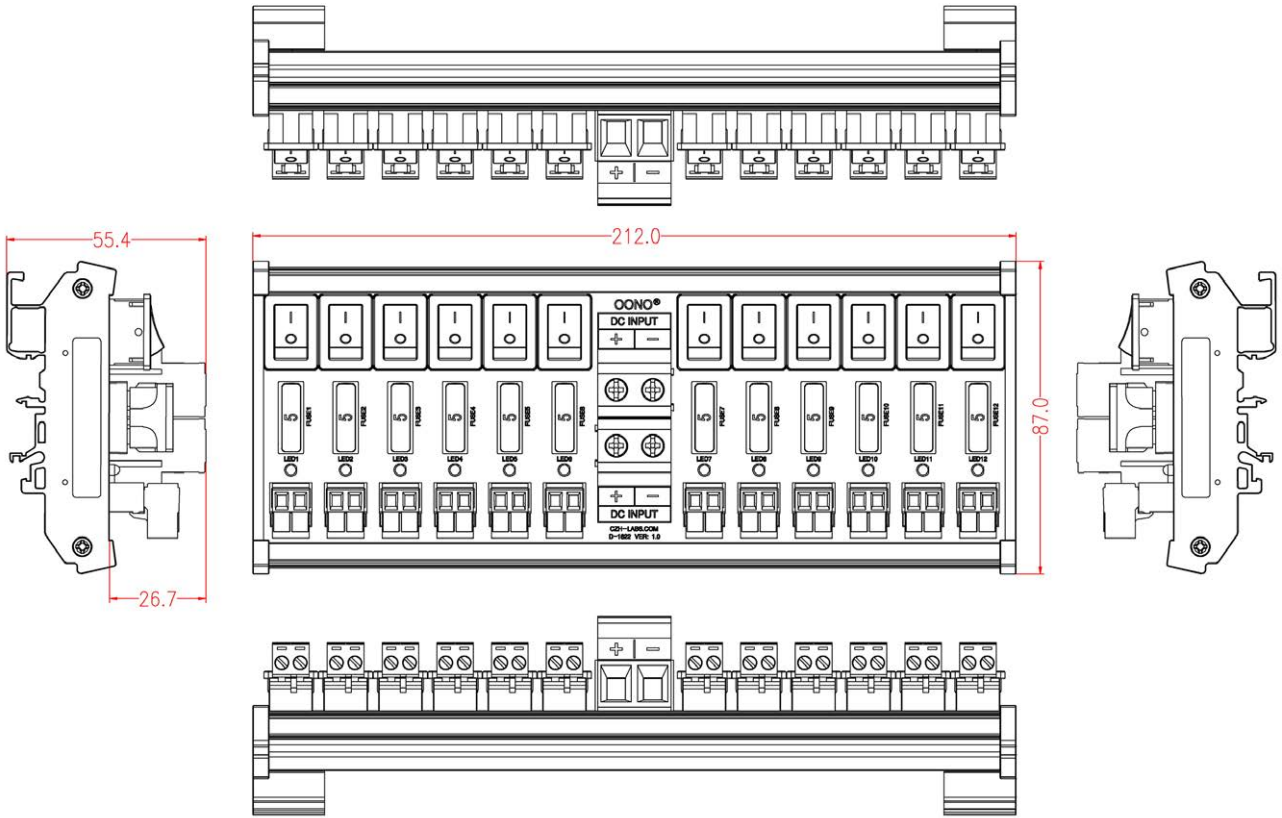

00NO® czh-labs.com	
MODEL NO: D-1622TV	SKU: MD-D1622TV-1
PROJECTION:	UNIT: mm

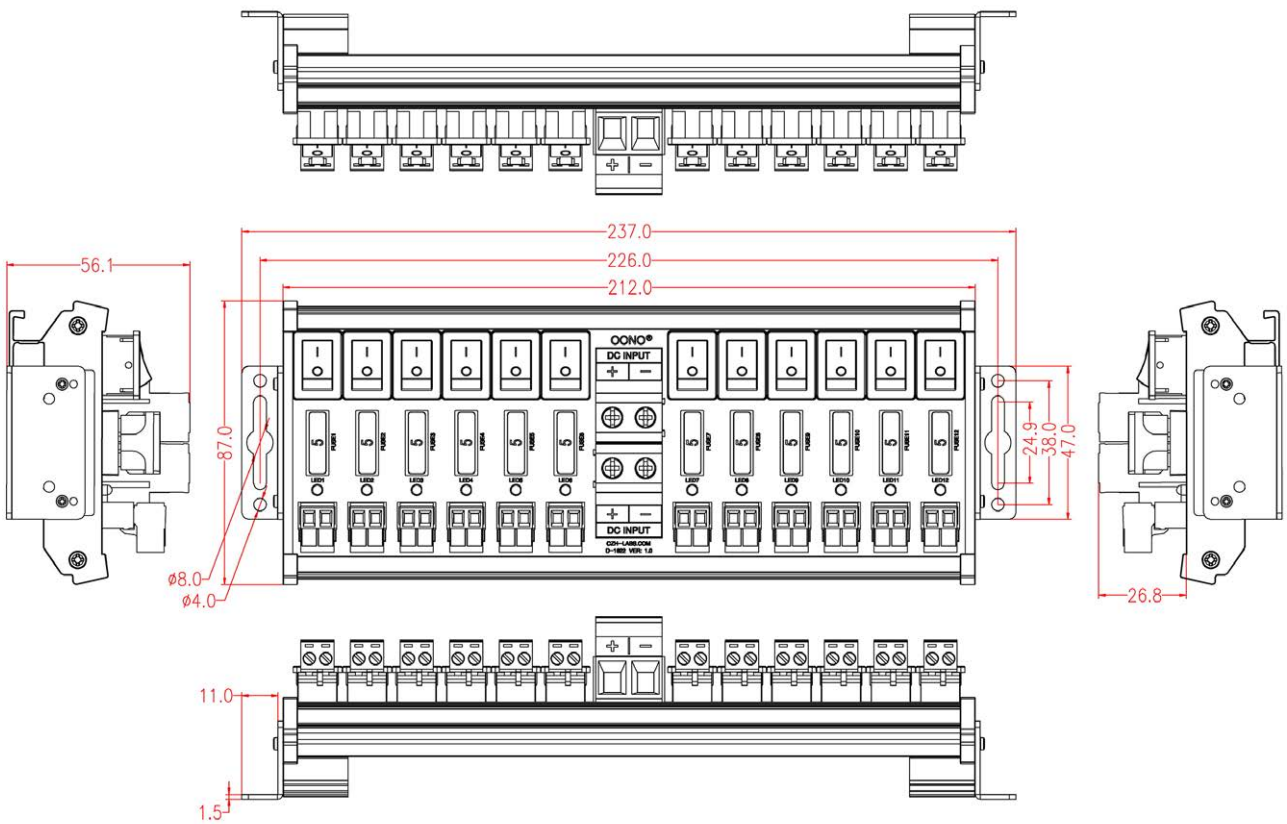

00NO® czh-labs.com	
MODEL NO: D-1622TVL	SKU: MD-D1622TVL-1
PROJECTION:	UNIT: mm

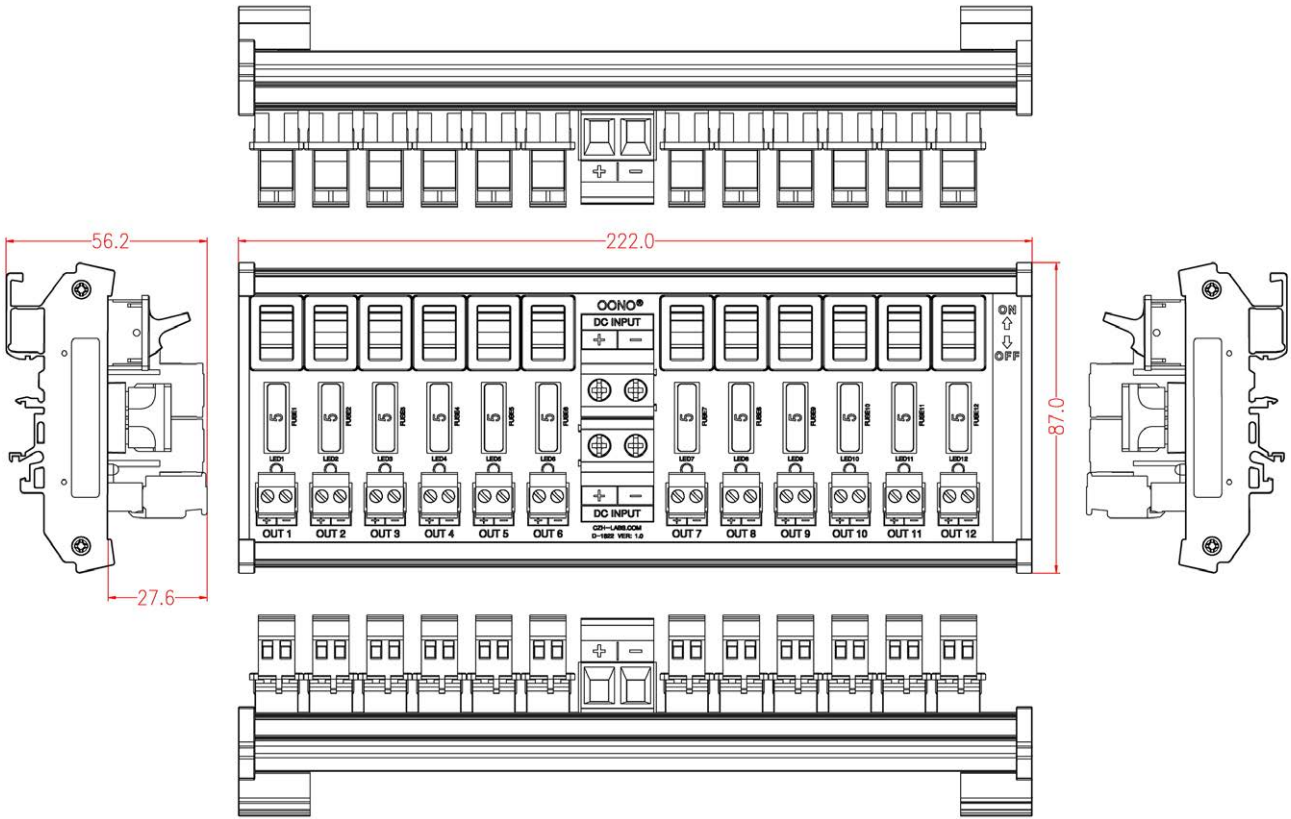

00NO® czh-labs.com	
MODEL NO: D-1622TKR	SKU: MD-D1622TKR-1
PROJECTION:	UNIT: mm

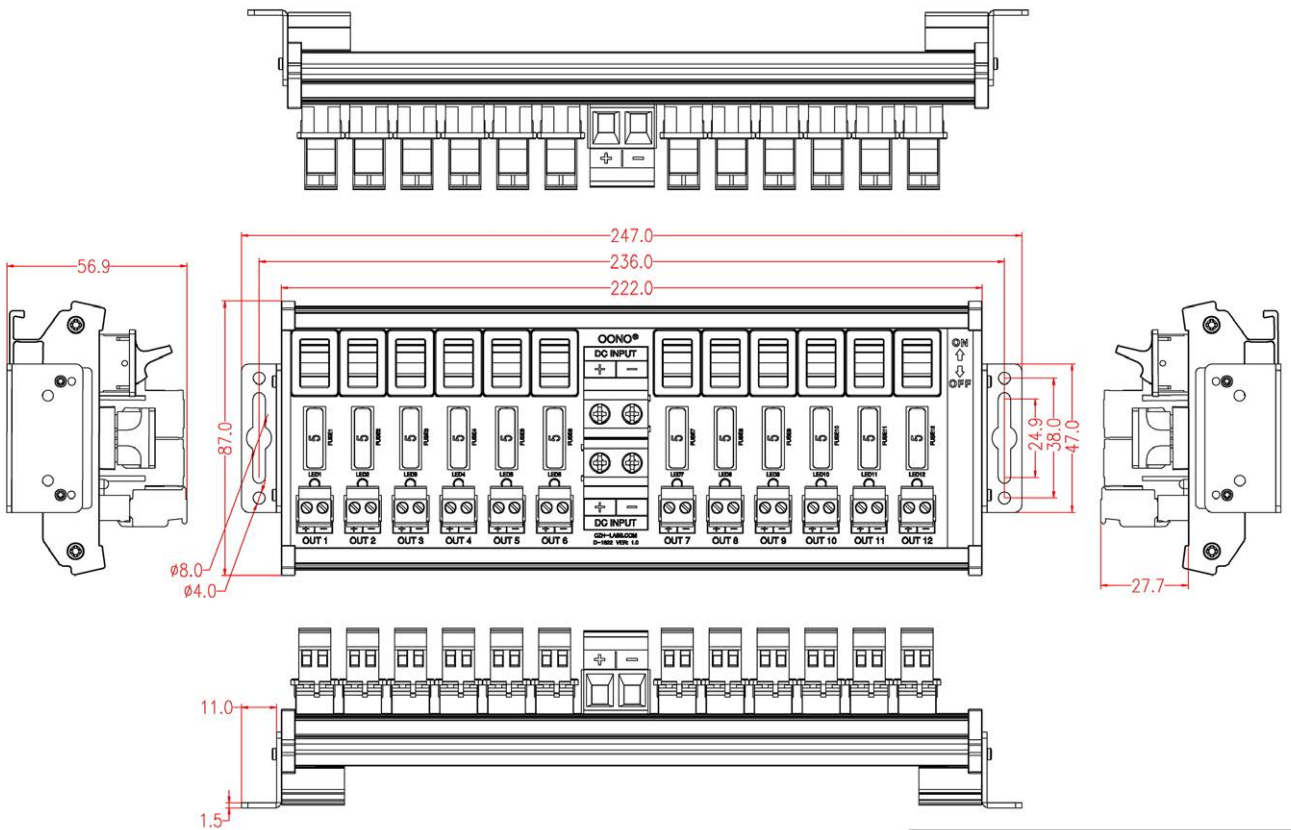

00NO® czh-labs.com	
MODEL NO: D-1622TKRL	SKU: MD-D1622TKRL-1
PROJECTION:	UNIT: mm

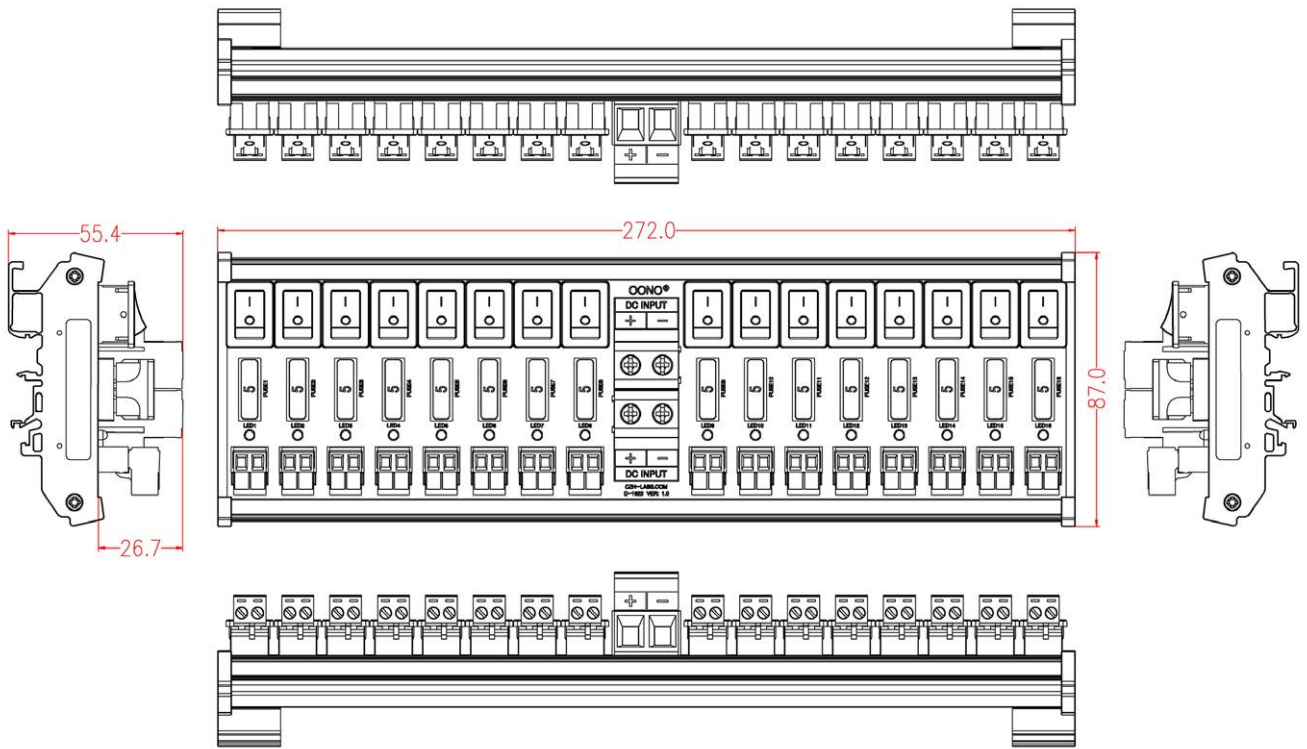

00NO® czh-labs.com	
MODEL NO: D-1623TV	SKU: MD-D1623TV-1
PROJECTION: 	UNIT: mm

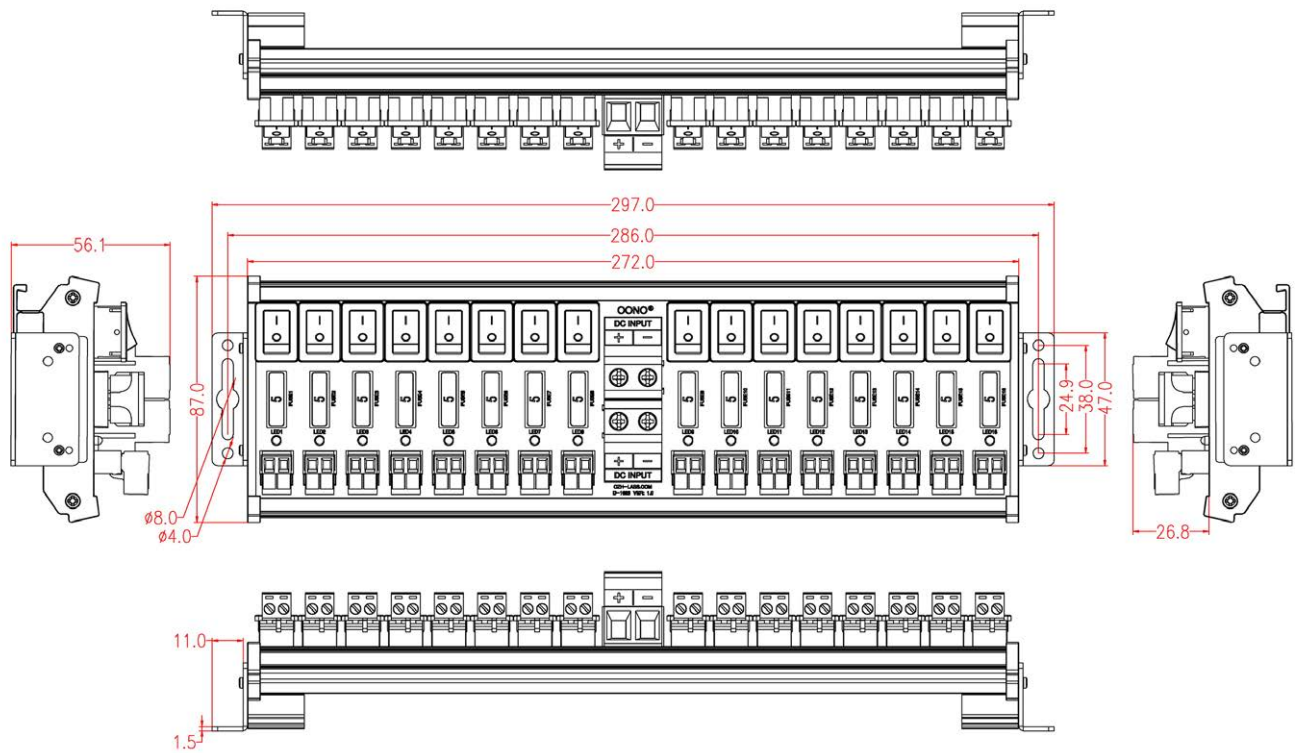

00NO® czh-labs.com	
MODEL NO: D-1623TVL	SKU: MD-D1623TVL-1
PROJECTION: 	UNIT: mm

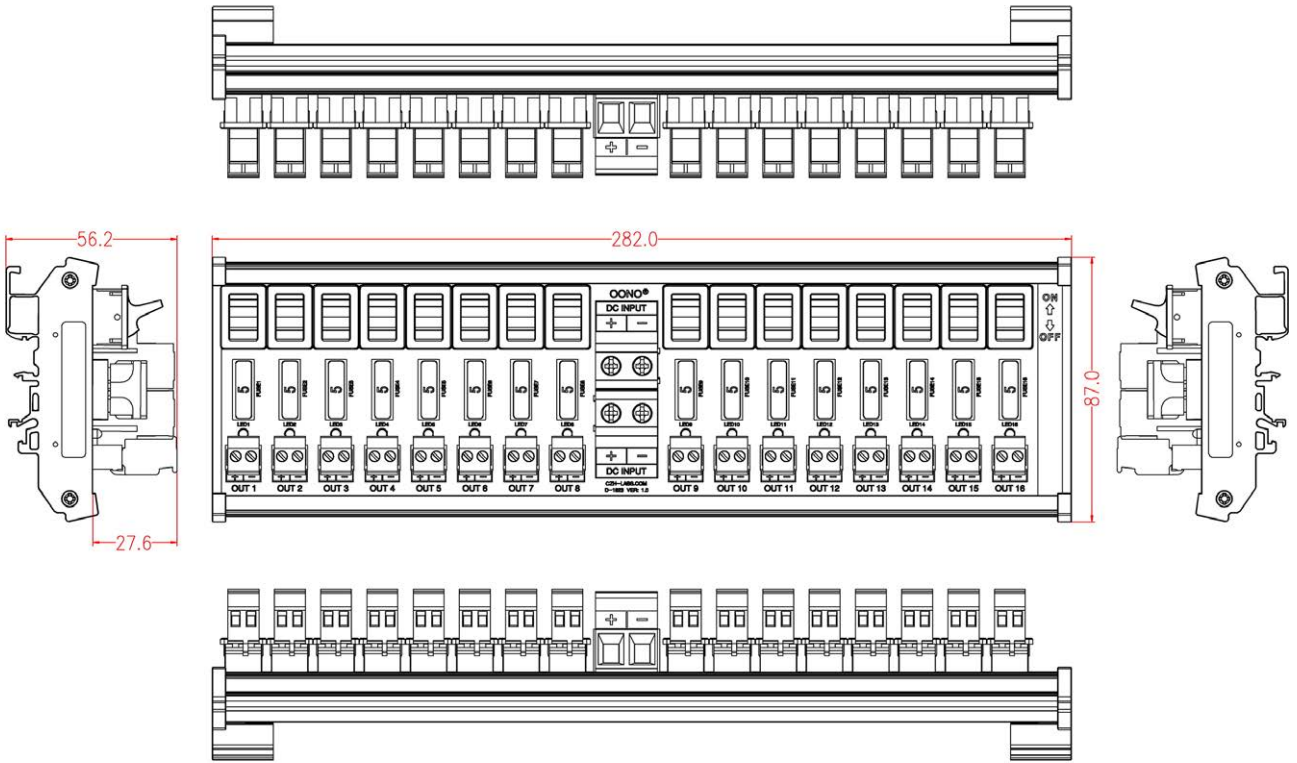

00NO® czh-labs.com	
MODEL NO: D-1623TKR	SKU: MD-D1623TKR-1
PROJECTION:	UNIT: mm

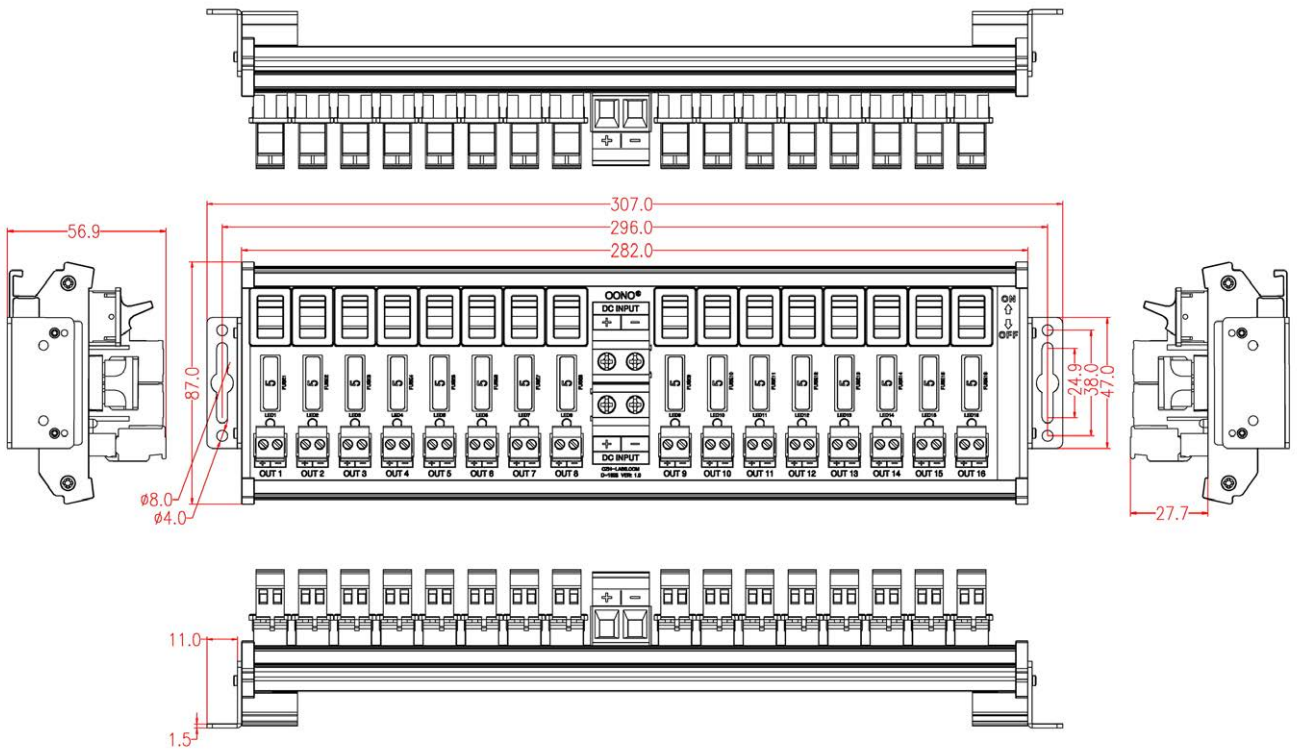

00NO® czh-labs.com	
MODEL NO: D-1623TKRL	SKU: MD-D1623TKRL-1
PROJECTION:	UNIT: mm

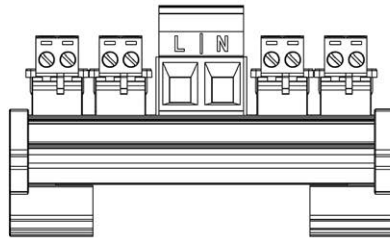
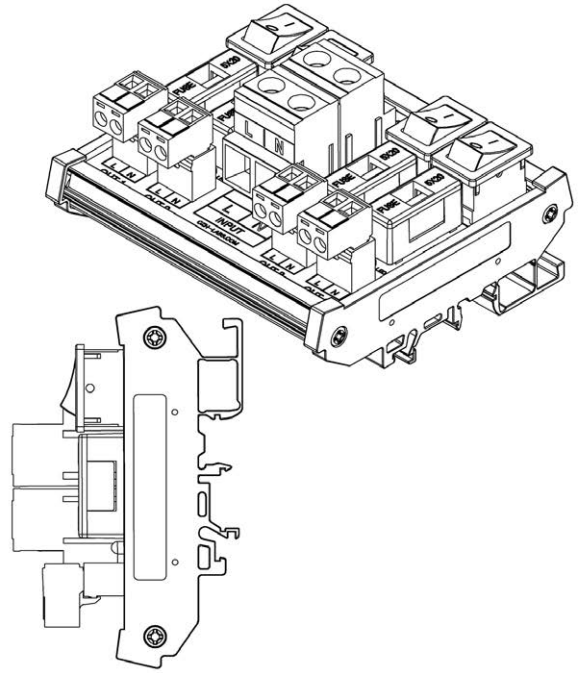
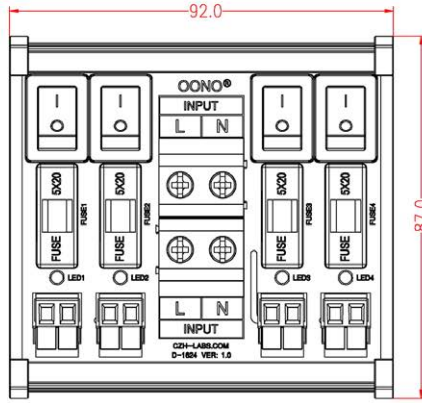
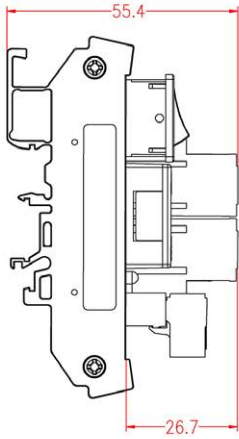
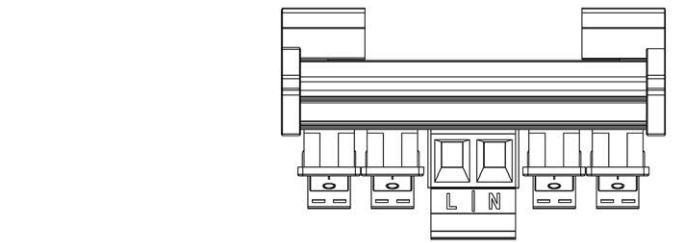

OONO® czh-labs.com	
MODEL NO: D-1624TV	SKU: MD-D1624TV-1
PROJECTION: 	UNIT: mm

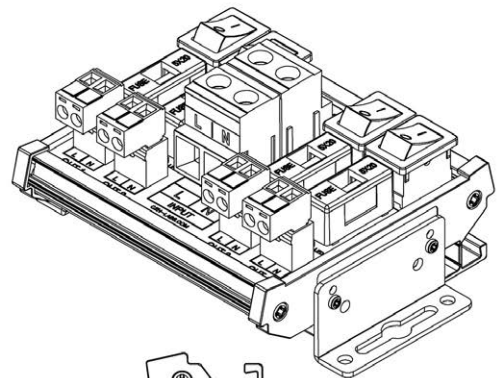
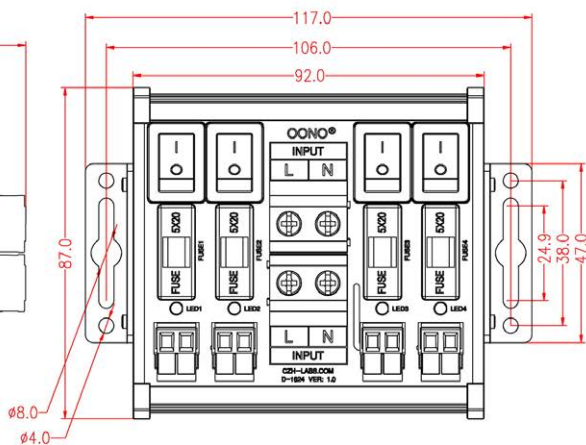
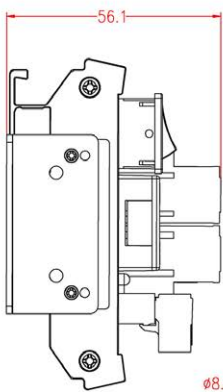

OONO® czh-labs.com	
MODEL NO: D-1624TVL	SKU: MD-D1624TVL-1
PROJECTION: 	UNIT: mm

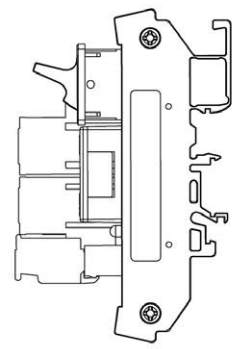
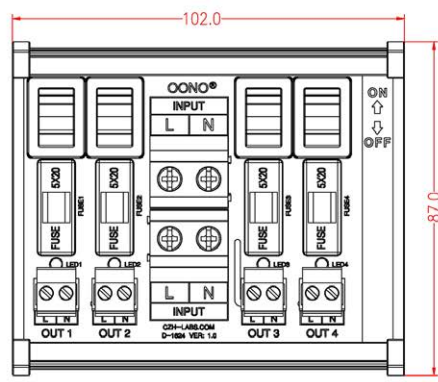
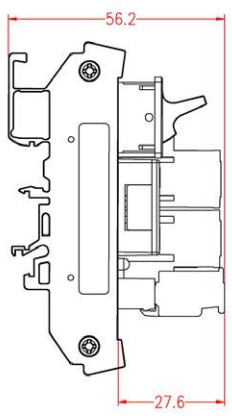
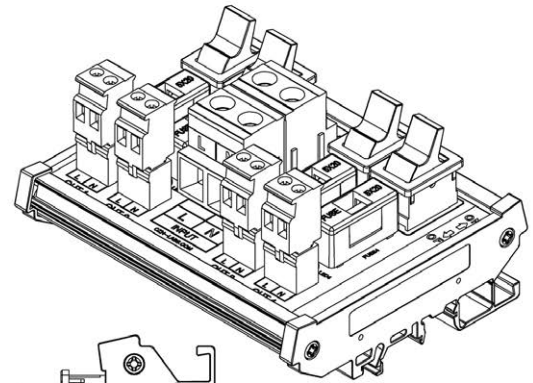

OONO® czh-labs.com	
MODEL NO: D-1624TKR	SKU: MD-D1624TKR-1
PROJECTION:	UNIT: mm

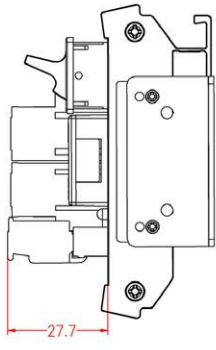
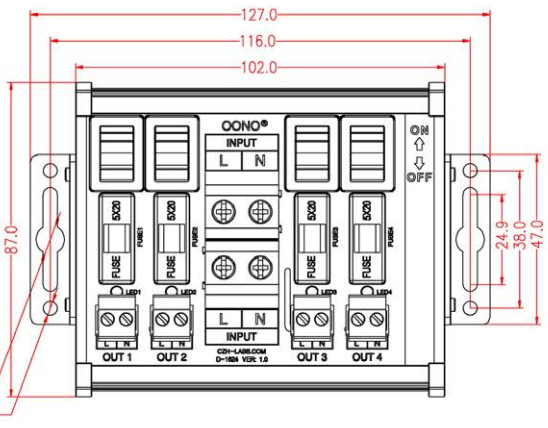
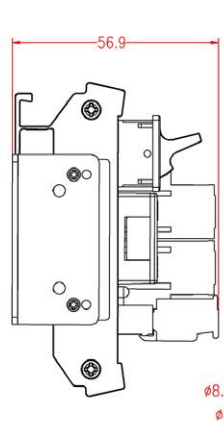
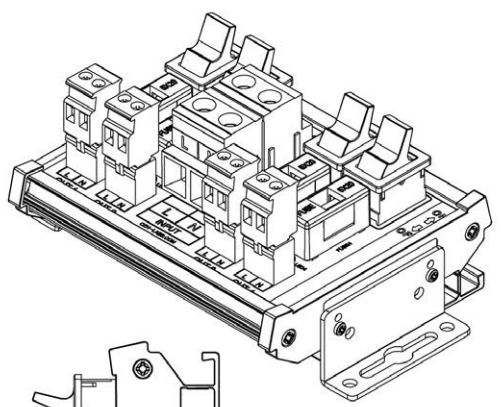

OONO® czh-labs.com	
MODEL NO: D-1624TKRL	SKU: MD-D1624TKRL-1
PROJECTION:	UNIT: mm

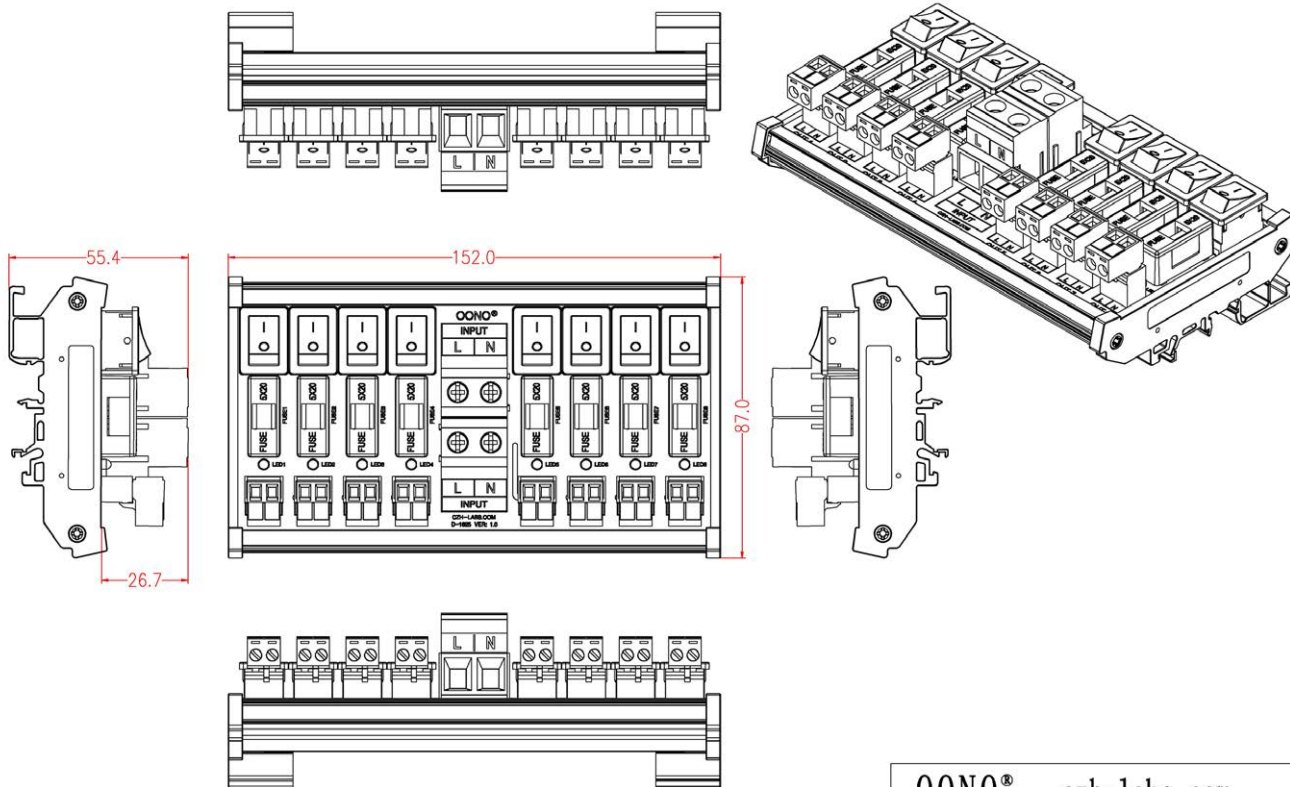

OONO® czh-labs.com	
MODEL NO: D-1625TV	SKU: MD-D1625TV-1
PROJECTION:	 UNIT: mm

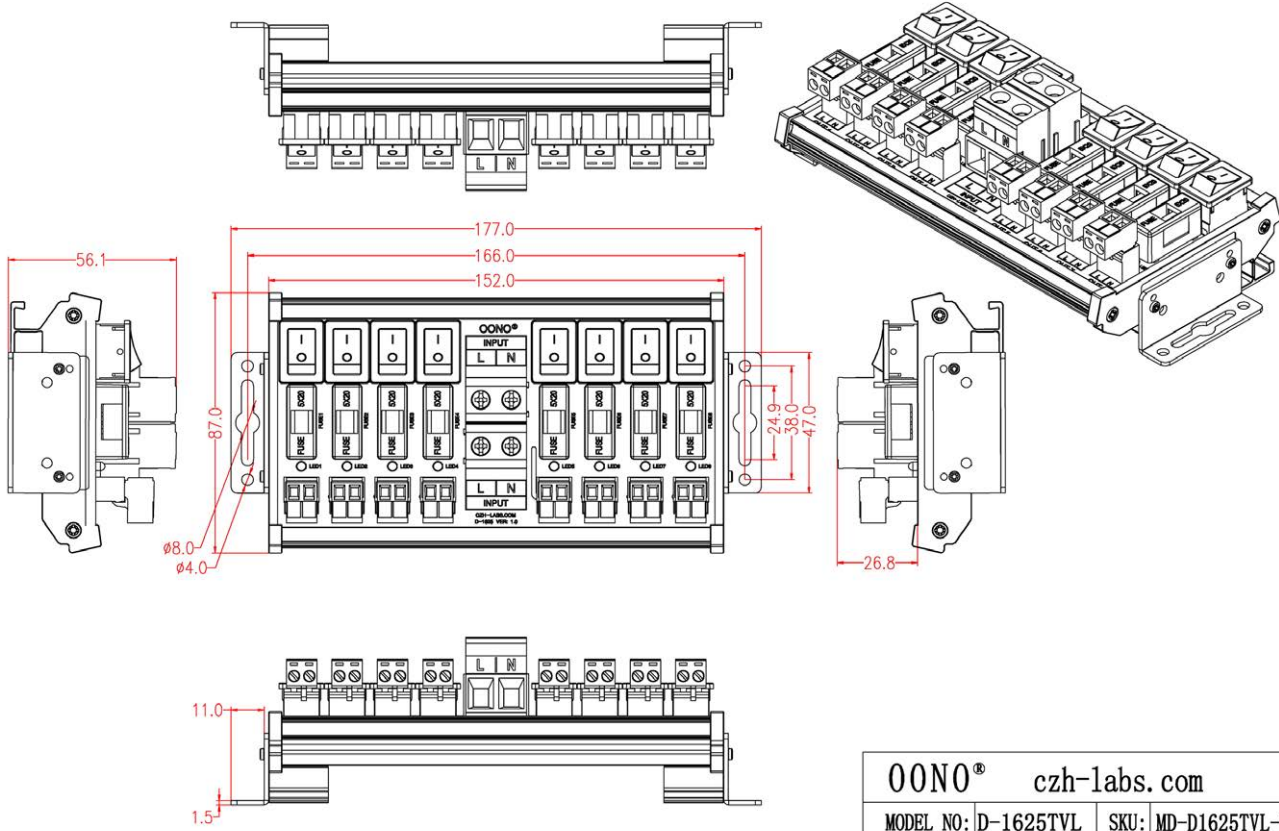

OONO® czh-labs.com	
MODEL NO: D-1625TVL	SKU: MD-D1625TVL-1
PROJECTION:	 UNIT: mm

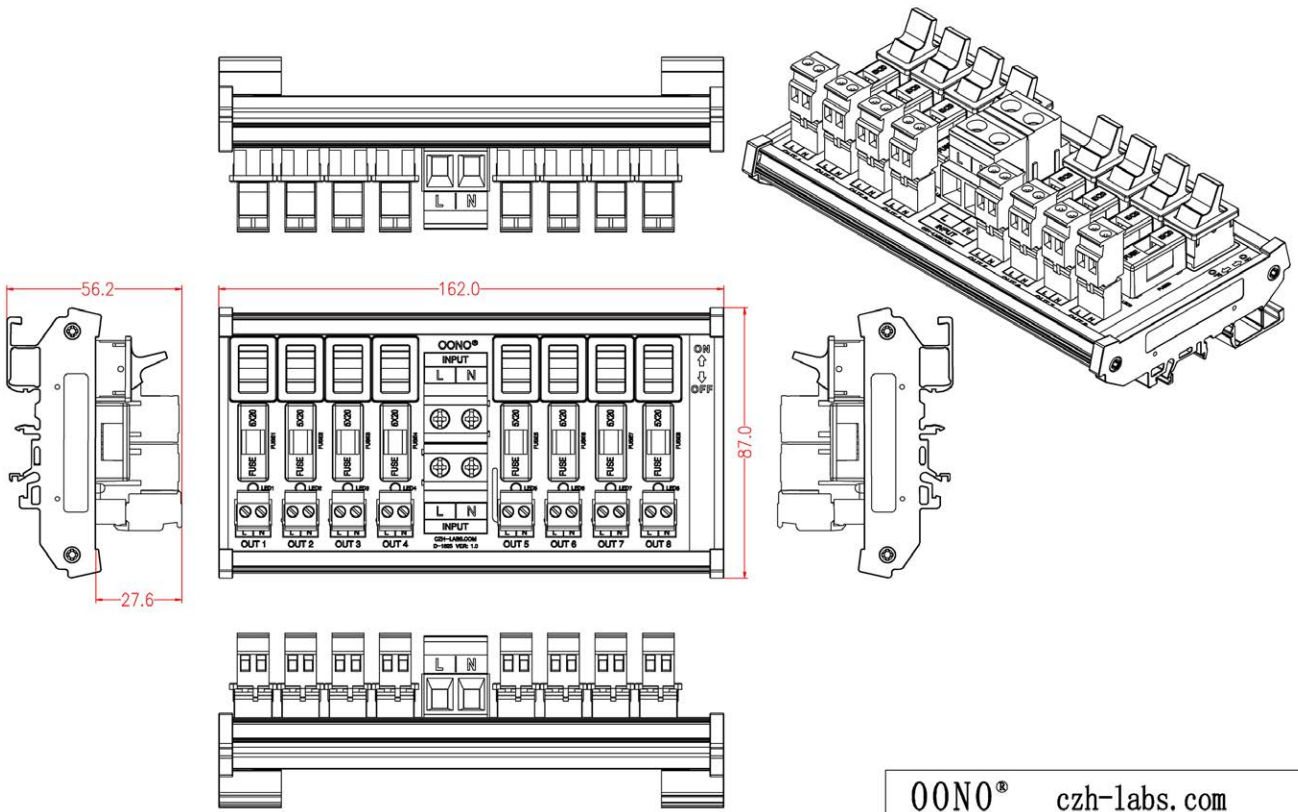

OONO®		czh-labs.com	
MODEL NO:	D-1625TKR	SKU:	MD-D1625TKR-1
PROJECTION:		UNIT:	mm

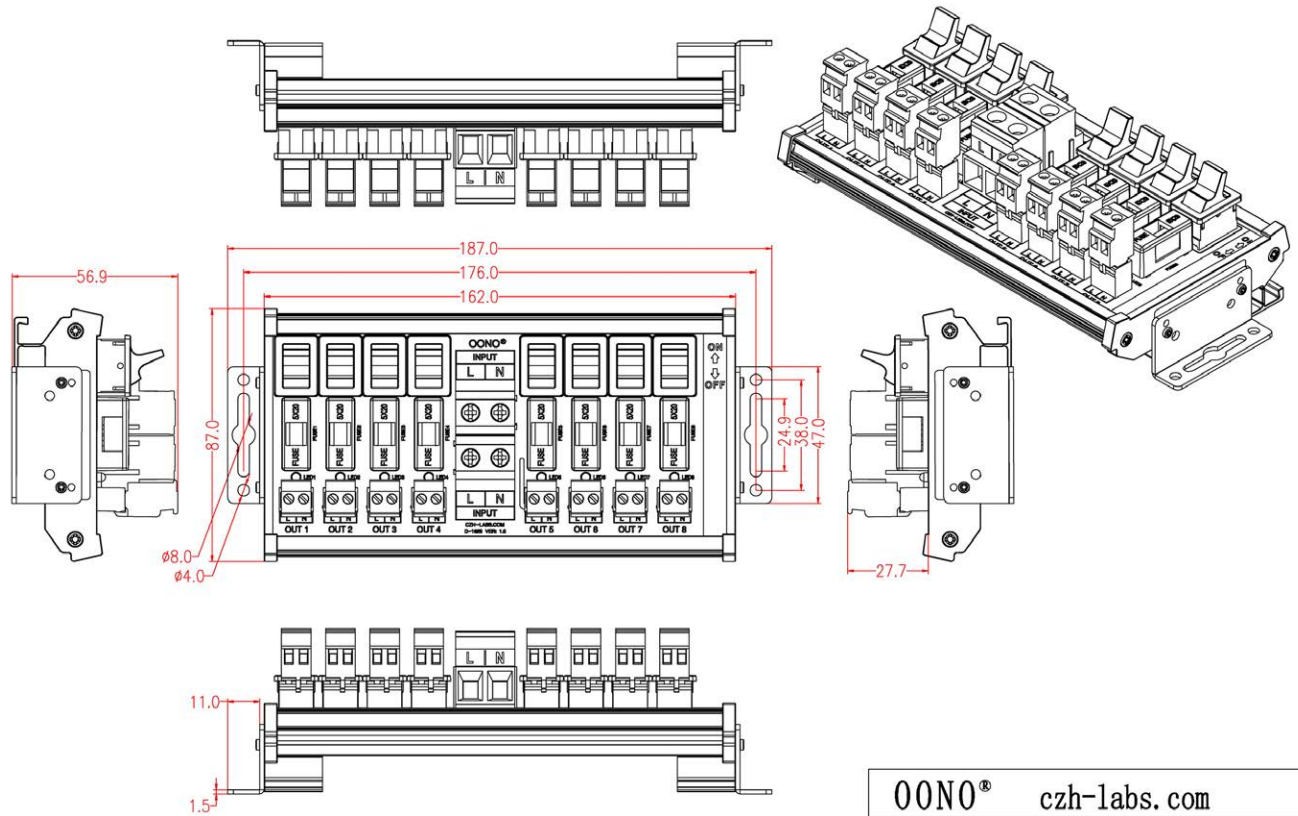

OONO®		czh-labs.com	
MODEL NO:	D-1625TKRL	SKU:	MD-D1625TKRL-1
PROJECTION:		UNIT:	mm

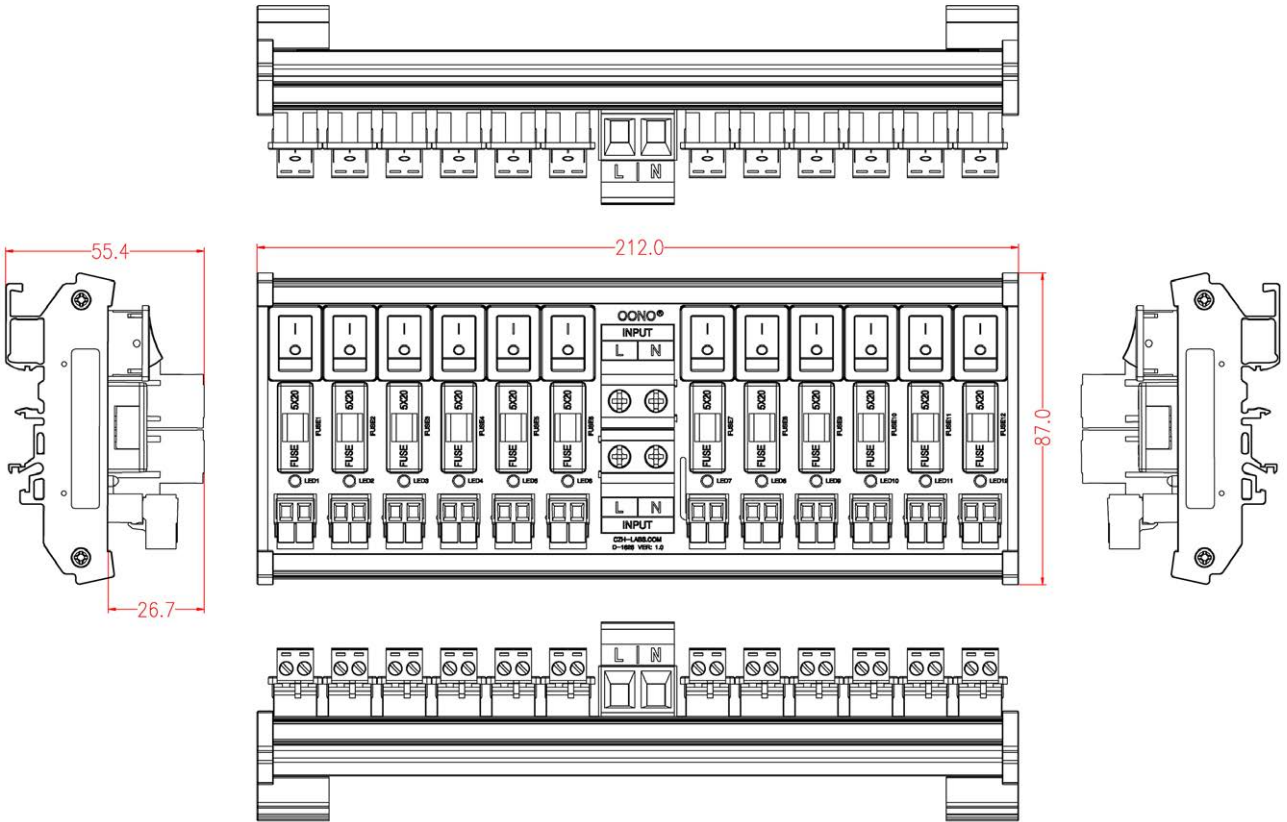

00NO® czh-labs.com	
MODEL NO: D-1626TV	SKU: MD-D1626TV-1
PROJECTION:	UNIT: mm

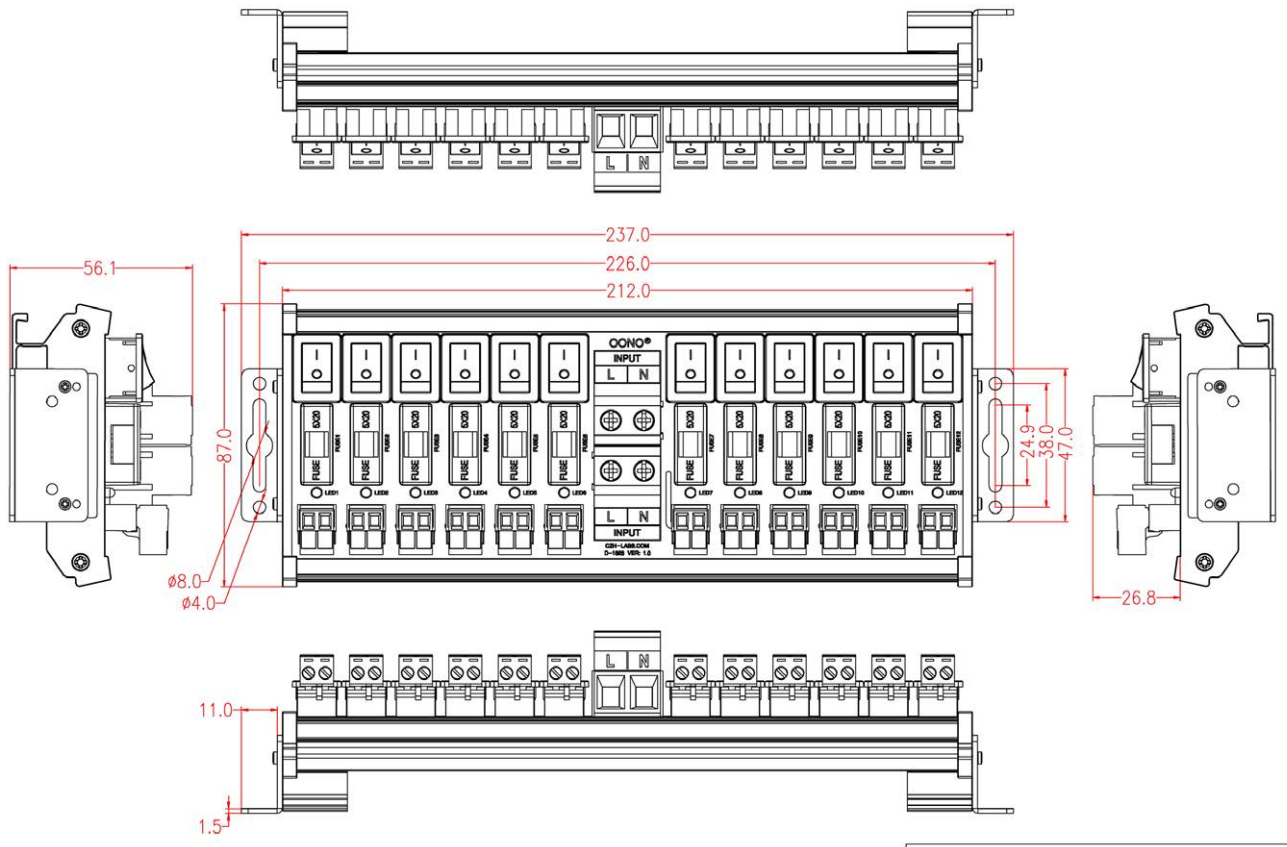

00NO® czh-labs.com	
MODEL NO: D-1626TVL	SKU: MD-D1626TVL-1
PROJECTION:	UNIT: mm

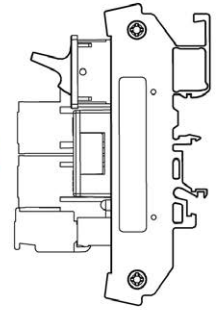
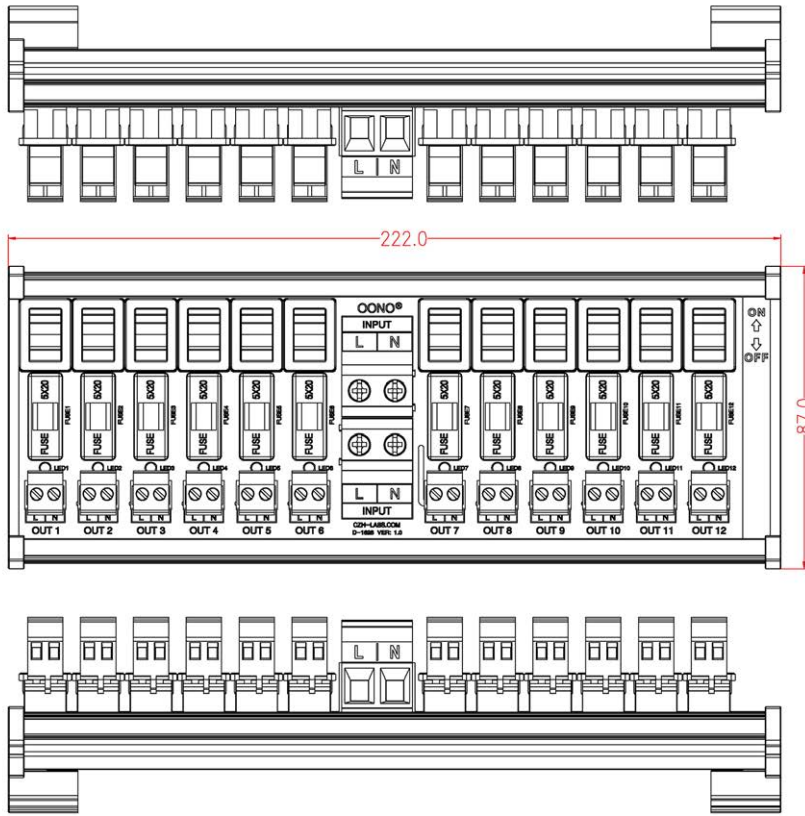
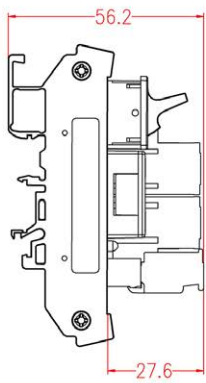

00NO® czh-labs.com	
MODEL NO: D-1626TKR	SKU: MD-D1626TKR-1
PROJECTION:	UNIT: mm

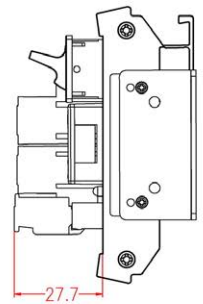
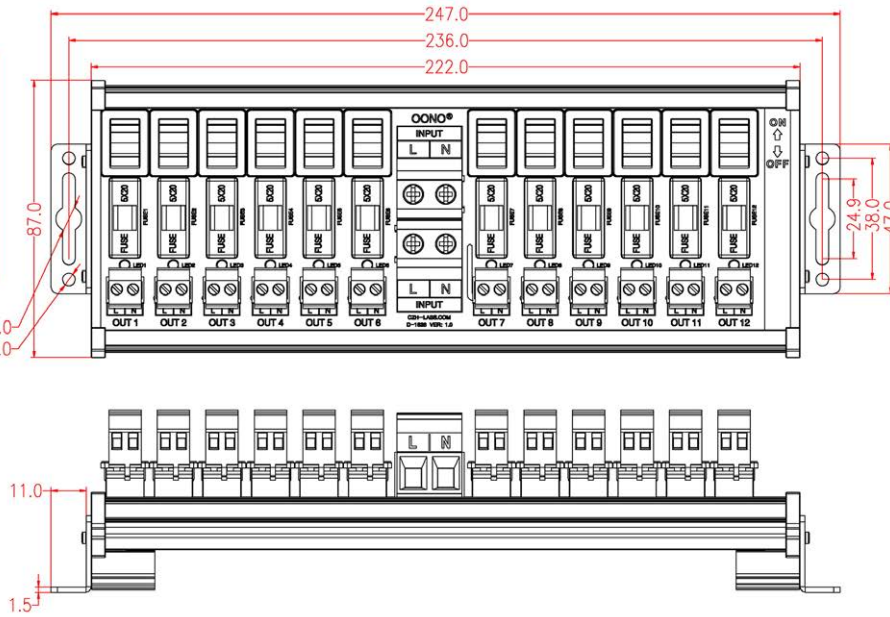
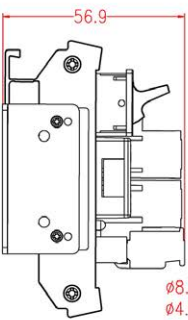

00NO® czh-labs.com	
MODEL NO: D-1626TKRL	SKU: MD-D1626TKRL-1
PROJECTION:	UNIT: mm

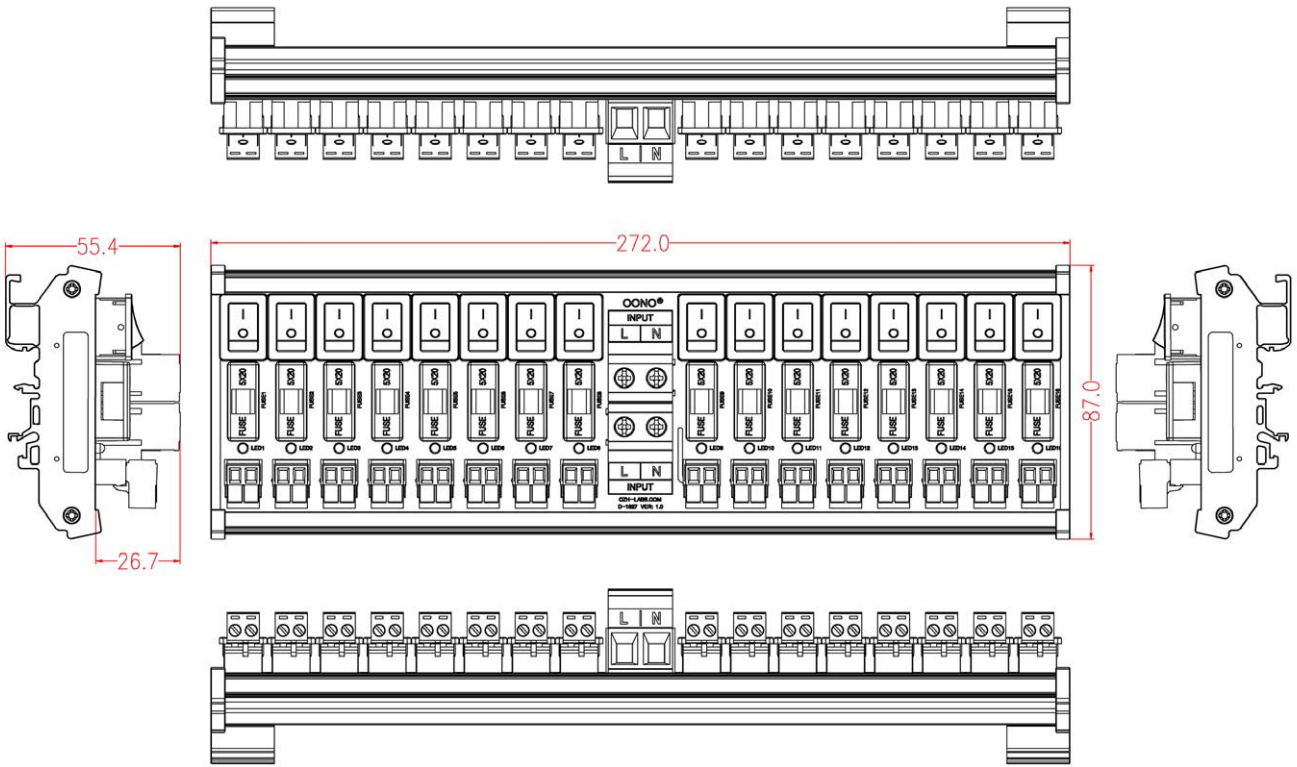

OONO® <a href="http://czh-labs.com">czh-labs.com</a>	
MODEL NO: D-1627TV	SKU: MD-D1627TV-1
PROJECTION: 	UNIT: mm

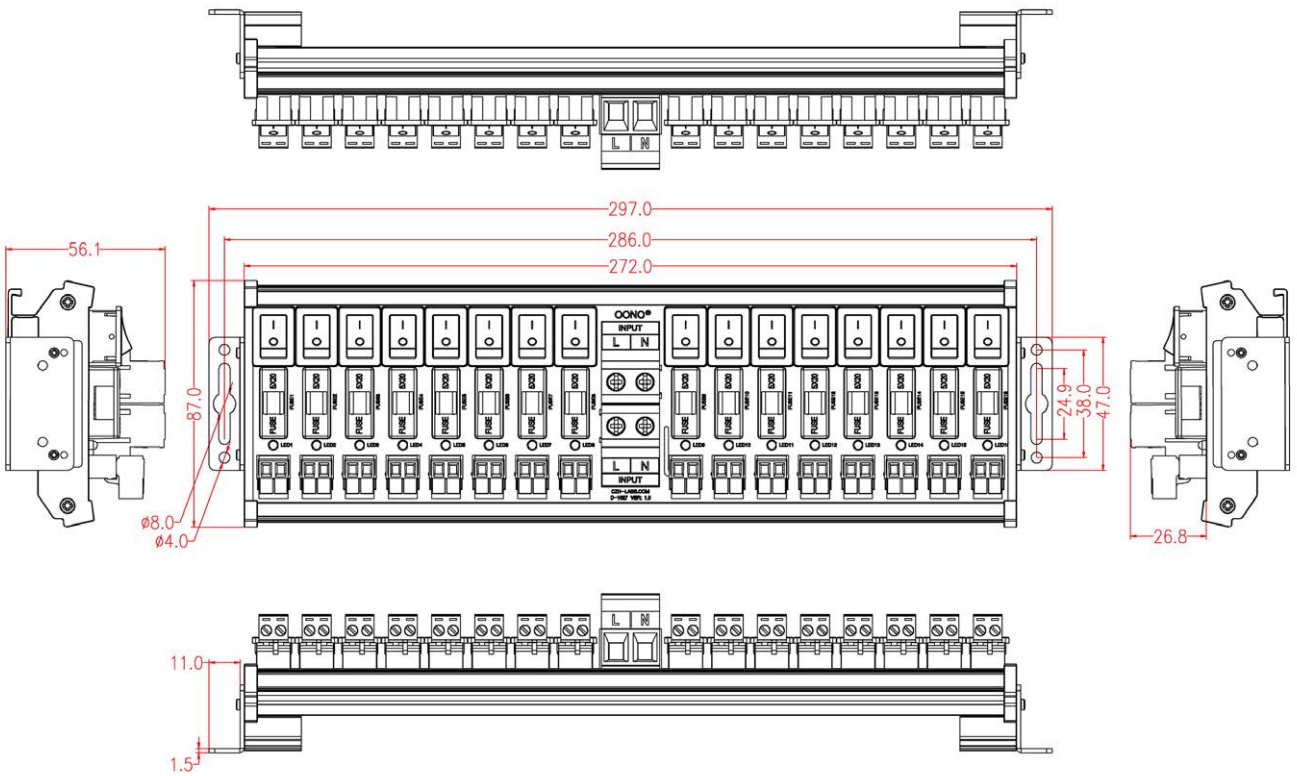

OONO® <a href="http://czh-labs.com">czh-labs.com</a>	
MODEL NO: D-1627TVL	SKU: MD-D1627TVL-1
PROJECTION: 	UNIT: mm

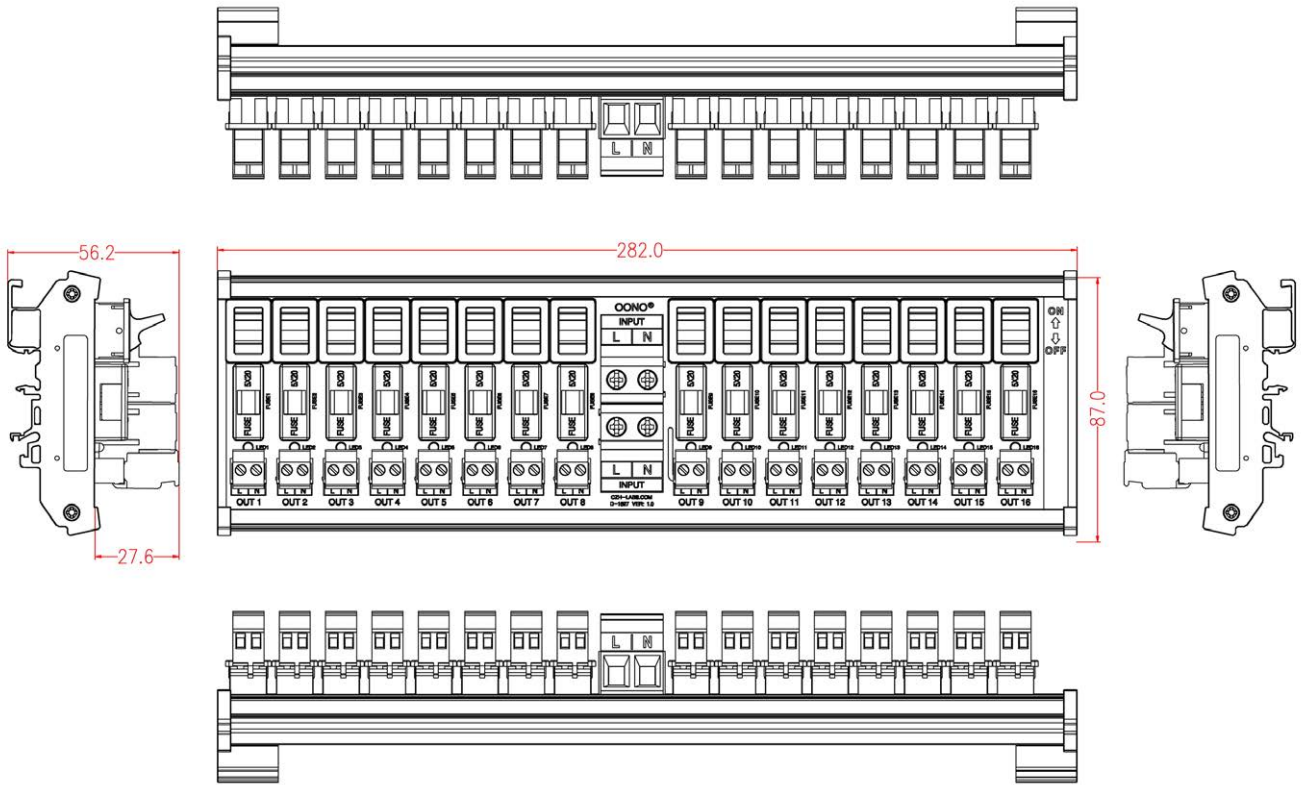

OONO® czh-labs.com	
MODEL NO: D-1627TKR	SKU: MD-D1627TKR-1
PROJECTION:	UNIT: mm

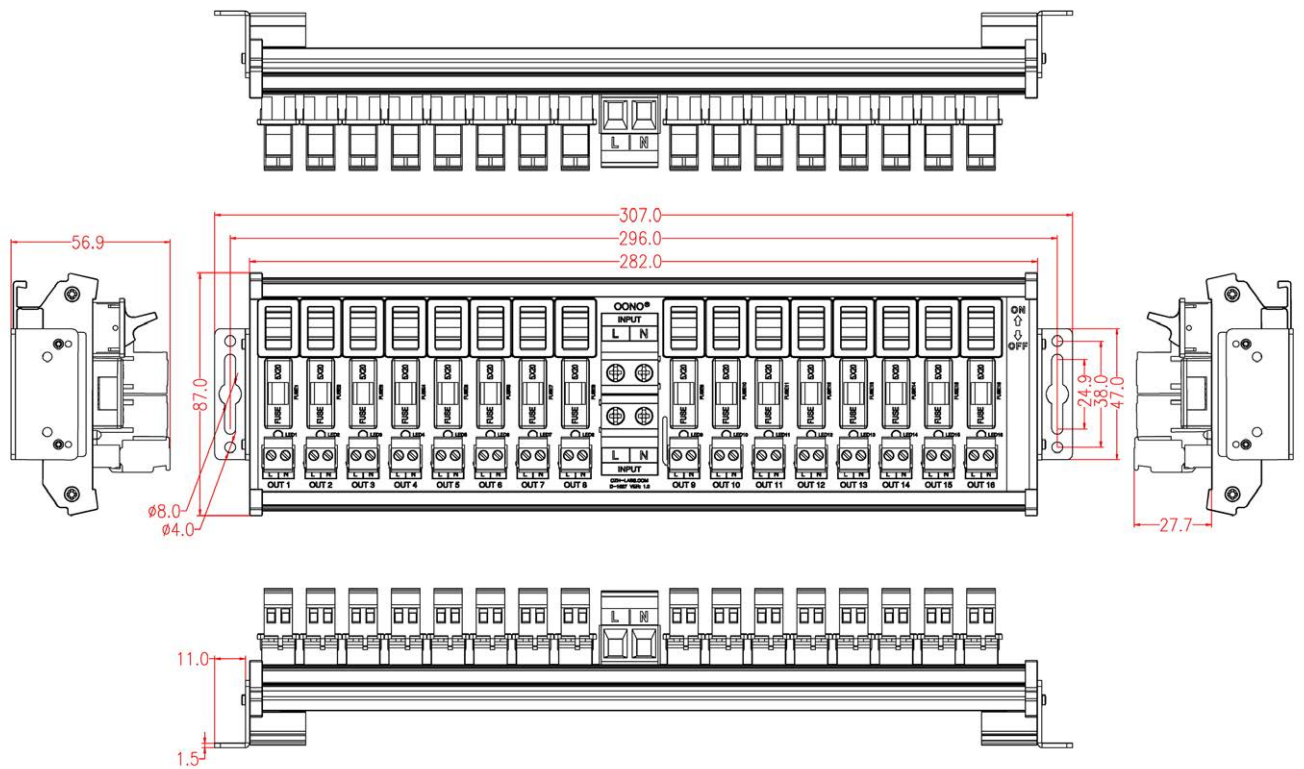

OONO® czh-labs.com	
MODEL NO: D-1627TKRL	SKU: MD-D1627TKRL-1
PROJECTION:	UNIT: mm